

OPERATIONS MANUAL

DPL4000

Portable Low Range Dew Point Analyzer



SuperSystems
incorporated

7205 Edington Drive / Cincinnati, OH 45249 / Tel (513) 772-0060 / Fax (513) 772-9466

Product Description:

This device is used to measure very low dew points with high accuracy and excellent long-term stability. It can be used across a wide range of temperatures and pressures, and it measures dew point in a variety of non-corrosive gases including Nitrogen, Argon, Hydrogen, and Sulfur Hexafluoride (SF6).

General Specifications:

Total Measurement Range:	-148°F to +32°F (-100°C to 0°C)
Optimal Measurement Range:	-112°F to -22°F (-80°C to -30°C)
Accuracy (Within Optimal Range):	+/- 3.6°F (+/- 2°C)
Accuracy (Outside Optimal Range):	+/- 5.4°F (+/- 3°C)
Operating Temperature Range:	-40°F to +140°F (-40°C to +60°C)
Operating Pressure Range:	0-725 psi / 0-50 bar
Operating Humidity:	Non-Condensing
Sensor Housing Classification:	IP65 – NEMA4 (AISI316L)
Display Housing Classification:	IP54
Display Weight:	400 grams
Power:	Rechargeable NIMH Battery (included) or 4 “AA” Batteries
Battery Recharging Time:	Approximately 4 hours
Battery Charger Input Requirements:	110-240 VAC/ 47-63Hz / 400mA
Run Time on Battery Power:	48 Hours – Continuous use / Up to 30 days - Data logging only
Output Units:	Dew Point /Frost Point, ppm & ppb (by volume), ppm (by weight)
Languages Supported:	Nine Possible Languages (See “Language” section)
Data Logging Capacity:	2700 points, user-selectable measurement interval
Data Logging Interval Options:	1s, 5s, 15s, 30s, 1min, 5min, 15min, 30min, 1h, 3h, 12h
Logging Duration Options:	1min, 5min, 15min, 30min, 1h, 3h, 12h, 24h, 7d, 31d, Memory Full

Calibration

It is suggested that this device should be calibrated on a routine basis, such as once per year or as prescribed by the user’s quality system requirements.

However, the DPL4000 *handheld display/data logger unit* does not require calibration since it only displays measurement data provided by the sensor/probe. Therefore, the handheld display/data logger unit does not need to be sent to SSi with the sensor/probe for calibration.

Sensor Technology:

The dew point measurement is based on a capacitive thin film polymer. Water molecules in the surrounding air or gas diffuse into the polymer layer through the permeable upper electrode, which changes the capacitance of the sensor. Changes

in capacitance can be directly correlated to the quantity of water molecules in the gas.

Special Features:

The dew point sensor in the DPL4000 performs two functions that provide increased accuracy and response time.

- **Automatic Calibration** – The sensor warms itself and performs an offset (zero point) correction. This is performed automatically at start up and after every 45 minutes of continuous use.
- **Sensor Purge** – This function evaporates all excess moisture molecules from the sensor to significantly increase the response time when the sensor goes from a wet condition to a dry condition. This is performed automatically at startup and after every 24 hours of continuous use. A Sensor Purge will also be initiated automatically when the sensor detects a large wet-to-dry environmental change.

Getting Started:

To begin taking measurements with the DPL4000:

- Connect a ¼" Male NPT quick-disconnect fitting (supplied) to the gas source. This fitting will not allow the gas to flow until the mating quick-disconnect fitting has been connected.
- Attach the sensor sampling assembly to the gas source using the quick disconnect fitting at the base.
- Start the flow of gas at approximately 10 CFH. Loosing and tightening the knob on the front of the flow meter will adjust the flow.
- Connect the small end of the Sensor Communication Cable to the port on the back of the sensor that is labeled "II". This will be the port without the rubber boot.
- Connect the other end of the cable to the handheld display using either one of the ports on the bottom.
- Turn on the power on the handheld display unit.
- If desired, change the environmental settings (selecting "NO" will use the default values).
- The instrument will need to go through some diagnostic tests including an automatic calibration and one or more sensor purges. During this time, the readings on the display will either indicate all dashes, or a dew point value that does not move. This condition will exist for between 5 and 15 minutes, depending on the dew point of the measured gas and the dew point that the sensor was exposed to prior to installation.

DPL4000 Components:



1. Handheld Display / Data Logger (PN 31428)
2. Sensor Assembly with Flow Meter
3. Sensor Communication Cable (PN 31429)
4. Battery Charger (PN 31707)
5. 1/4" Male NPT Quick Disconnect Fittings with Shutoff (2) (PN 34664)
6. Software CD
7. USB Cable for Downloading Data
8. Operations Manual
9. Plug for Unused Port on Handheld Display
10. Contact Plate for using "AA" batteries
11. Carrying Case
12. Battery Pack (PN 32015)

Installing and Removing the Battery Pack

The DPL4000 is supplied with a rechargeable battery pack. It is also possible to power the instrument using four (4) "AA" 1.5V

alkaline batteries. To use the alkaline batteries, you will need to install the supplied metal contact plate at the base of the battery housing.

1. Unscrew the back plate of the indicator.
2. Remove the old batteries. If a rechargeable battery is installed, remove the black connector by gently pulling up on the wires.

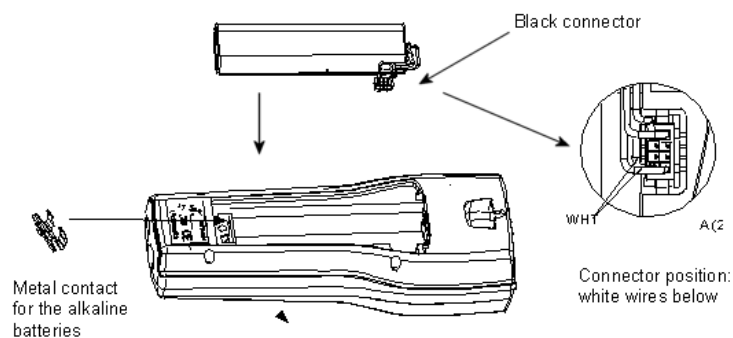

Figure 1 Installing the Battery Pack

3. Connect the black connector of the new rechargeable battery pack. Make sure the red and black wires are on the upper edge of the connector. Do not push the connector with any conducting material. If using alkaline batteries, the metal contact plate will need to be inserted if it is not already present.
4. Close the back plate, and tighten the screw.
5. Charge the battery before use.

Charging the Battery Pack

1. Plug the charger into the top of the indicator (located under the rubber cap).
2. Connect the charger to a wall socket. A dynamic battery symbol will be visible in the top left corner of the display.
3. When the battery symbol does not change, the battery pack is fully charged.
4. Disconnect the charger.

The duration of recharging is typically 4 hours.

Buttons and Navigation

To turn on the device, press the **Power On/Off** button. To open menus, press an arrow button and then press the shortcut buttons. To activate a function shown above the shortcut button, press the shortcut button. To navigate in the menus, press arrow buttons.

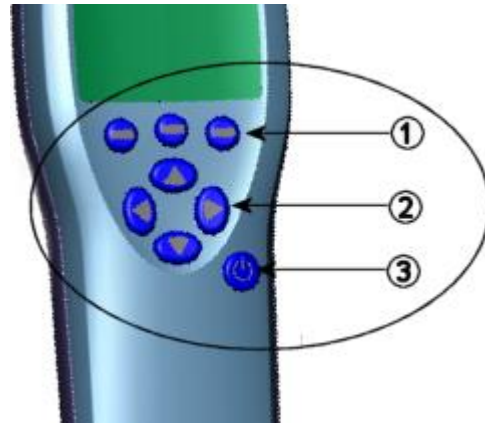

0403-033

Figure 2 Buttons

The following numbers refer to Figure 2 above.

- 1 = Shortcut buttons
- 2 = Arrow buttons
- 3 = Power on/off button

Turning on the Device

1. Connect the Sensor Assembly to either one of the base connectors in the indicator.
2. Press the **Power On/Off** button.
3. If desired, adjust the environmental settings in the instrument.

Pressure (P) - Preset to Atmospheric Pressure at time of manufacture









Specific Gravity (G) – Preset for Nitrogen

NOTE: For most applications, the default values for each of these settings will be appropriate. The variations in Atmospheric Pressure will have negligible impact on the resulting dew point. The Specific Gravity is not used in the

calculation of dew point. It is only used in the determination of ppm/ppb (parts per million/billion of water). If only dew point is displayed, the Specific Gravity value can be ignored.

Menus

The settings can be changed and functions can be selected in the menus. Follow the instructions below:

1. Open the main menu by pressing one of the     buttons.
2. Press  **Open** within 5 seconds. Otherwise, the basic display returns. If this happens, start from step 1 again.
3. Move in the menu using the   buttons.
4. Select an item with the  button.
5. To return to the previous level, press .
6. To return to normal operation, press **Exit**.

Display Menu

Quantities and Units

You can select between 1 and 3 quantities to display at one time. The options are:

- PPB (Parts Per Billion Water – by volume)
- Tdf (Dew Point / Frost Point Temperature)
- PPM (Parts Per Million Water – by volume)
- PPMW (Parts Per Million Water – by weight)

For Dew Point, the units can be selected by pressing the “UNIT” button.





Rounding

You can select a one- or two-decimal display using **Rounding**. As a default, rounding is turned on (a one decimal display is in use).

Hold/Save

With the **Hold/Save** function you can hold a selected display reading and save it into the memory. Several readings can be saved. The reading saved first is called data point 1, the second saved reading is called data point 2, and so on. All the individual readings (data points) are stored in the same file marked with . The file will remain in the indicator memory even when the indicator is switched off.







Graphic History

The graphical display shows the measurements as a curve. From the curve, you can examine the data trend and history of the last minutes. To zoom in a curve, press . To zoom out, press . To move the curve horizontally, press  .

Functions Menu

Alarm

The DPL4000 can be set to beep and have the backlight blink when the measurement exceeds pre-determined limits. The alarm level(s) can be set for only one quantity at a time. To set the alarm levels, follow the instructions below:

1. Open the menu by pressing   **Open**.
2. Select  **Functions** and press .
3. Select  **Alarm** and press .
4. Select **Quantity** and press  **Set** to select the quantity. Since the instrument defaults to only displaying Dew Point (Td/f), this will be the only quantity available. Only one active quantity can be selected at a time. To change which

quantities are active, go to **Menu** - **Display** - **Quantities and units**.

5. Select the first limit and press **⊖ Set** (if the alarm function is on, turn it off). Use the arrow buttons to set the alarm level. To select the sign for the alarm level, press the **⊖ +/-** button. To save the settings, press **⊖ OK**.
6. Select the second limit and follow the instructions in step 6. The alarm will go off when either the upper or lower limit is exceeded. If you will use only one limit, set the upper or lower value to an extreme so that it will never be reached.
7. To activate the alarm and to return to the basic display, select **Alarm On/Off** and press **⊖ On**. The note symbol ♪ will appear in the upper left corner of the display.
8. When the alarm level is reached, you can stop the alarm by pressing **⊖ OK**. To reactivate the alarm, press **⊖ Yes**. To completely stop the alarm, press **⊖ No**.

NOTE

The alarm does not work when the device is turned off.

Analog Input

This feature has not been enabled on the DPL4000. It is possible to obtain an analog output directly from the sensor. For information on this procedure, please contact Super Systems Inc.

Recording/Viewing Menu

Recording Data

You can record measurement data and view it on the display of the DPL4000. To record data, do the following:

1. Press **⊖ Record** or open the menu and select **Recording/Viewing**.

2. Select **Record data** and press **▶**.
3. To change the recording interval, select **Interval** and press **⊖ Set**.
4. Select the measurement interval with the arrow buttons. The measurement intervals and the maximum recording times are shown in Table 1 on page 10.

Table 1 Measurement Intervals and Maximum Recording Times





Measurement Interval	Maximum Recording Time (Memory Full)		
	1 quantity	2 quantity	3 quantity
1 s	45 min	22 min	15 min
5 s	3 h	113 min	75 min
15 s	11 h	5 h	3 h
30 s	22 h	11 h	7 h
1 min	45 h	22 h	15 h
5 min	9 days	4 days	3 days
15 min	28 days	14 days	9 days
30 min	56 days	28 days	18 days
1 h	113 days	56 days	37 days
3 h	339 days	169 days	112 days
12 h	1359 days	678 days	451 days

5. Press **⊖ Select**.
6. To set the duration of the recording, select **Duration** and then press **⊖ Set**. Select the duration with the arrow buttons and press **⊖ Set**.
7. To start recording, select **Start/Stop recording**, press **⊖ Start**. If you choose Memory full, you will see the maximum recording time on the display. You can also delete files to empty the memory. To accept the maximum recording time, press **⊖ Start** again.
8. You can switch off DPL4000 during recording to save the battery. A message will appear on the display to inform that recording will continue undisturbed even when the power is turned off. If the indicator is switched off during recording, the progress bar is shown on the display every 10 seconds (continuously if the charger is connected). The bar indicates the amount of recorded data.











CAUTION

Do not disconnect the probe when the data recording is on, even if the indicator is turned off. This may cause loss of recorded data.

Stopping Recording







1. To stop recording, press  **Record**.
2. Select  **Record data** and press .
3. Then select **Start/Stop recording** and press  **Stop**.
4. To view the recorded file, select  **Show**.

View Recorded Data

1. Open the menu by pressing   **Open**.
2. Select  **Recording/Viewing** and press .
3. Select  **View recorded data** and press .
4. Select the file you want to view and press . The files are identified according to the starting date and time of recording.
5. To go to the graphical view, press  **Graph**. To view the recording time stamps, press  **Times**. To return to the recording values, press  **Values**.
6. To return to the basic display, press  **Exit**.

Memory Status

You can check the memory status as follows:

1. Open the menu by pressing   **Open**.
2. Select  **Recording/Viewing** and press .
3. To view the amount of memory that is in use and the estimated free space left, select **Memory status** and press  **Show**.
4. To return to the basic display, press  **OK** and  **Exit**.

NOTE

The estimate of available free space is calculated for the current number of active quantities. If you change the displayed quantities, the estimate will change accordingly.

Clear Data Memory

The data memory can be cleared as follows:

1. Open the menu by pressing **▶** **⊖** **Open**.
2. Select **▶** **Recording/Viewing** and press **▶**.
3. Select **Clear data memory** and press **⊖** **Clear**. To confirm the deletion, press **⊖** **Yes**.
4. To return to the basic display, press **⊖** **Exit**.

Transferring Recorded Data to PC

The recorded data can be transferred to a PC using the DPL4000 / MI70 Link program. With this software the recorded data can be examined and saved easily in the Microsoft Windows® environment and transferred to a spreadsheet program, such as Microsoft Excel®, for modifications.

The software contains the driver needed for the USB connection. When installing the software, it is important that the USB cable is not connected. The MI70 Link Setup Wizard will install the DPL4000 / MI70 Link Software on your computer. Installing the USB instrument driver can take a few minutes. After the installation is finished, connect the USB cable to the USB port on your PC. Windows will detect the new device and use the driver automatically.

You can now start monitoring the DPL4000 readings in real time with a PC using the MI70 Link program.

Environment Menu

Pressure Settings

In pressurized environments, the actual process pressure value must be set. The pressure in “bara”. This is the absolute process pressure in the unit of bar.

Specific Gravity Settings

The Specific Gravity is not used in the calculation of dew point. It is only used in the determination of ppm/ppb (parts per million/billion of water). If only dew point is displayed, the Specific Gravity value can be ignored. If ppm/ppb calculations are going to be performed, the specific gravity of the gas that is being measured must be entered. This information can be found from a variety of sources on the Internet.









Settings Menu

User Interface







Language

You can select any of the following languages for the user interface: English, Finnish, Chinese, Russian, Japanese, Swedish, French, German, or Spanish.

To select the language, follow the instructions below:









1. Open the menu by pressing   **Open**.
2. Select  **Settings** and then press .
3. Select  **User interface** and then press .
4. Select **Language** and press  **Set**.
5. Then select the desired language and press  **Select**.
6. To return to the basic display, press  **Exit**.

If you accidentally selected a language you do not want, follow the instructions below:

1. Return to the basic display by pressing the rightmost  until the basic display appears.
2. Go to the **Language selection** menu by pressing first  and then the  button in the middle.
3. Then press , then , then  again and finally press again the  button in the middle.
4. Reselect the language.







Automatic Power Off

To save battery life, the DPL4000 can be set to turn off automatically after a period of inactivity. As a default, this feature has been turned off. This will allow for extended periods of datalogging without the risk of interruption from power loss. To adjust this setting, see the instructions below:

1. Open the menu by pressing   **Open**.
2. Select  **Settings** and press .
3. Select  **User interface** and press .
4. Select **Auto power off** and press  **Set**.
5. Select the inactivity time and press  **Select**.
6. To return to the basic display, press  **Exit**.

Program Shortcut Keys

As a default, the three shortcut keys refer to **Graphic**, **Hold/Save**, and **Record** functions. You can change any of the shortcut keys to refer to functions that better suit your needs. See the instructions below:

1. Open the menu by pressing   **Open**.
2. Select  **Settings** and press .
3. Select  **User interface** and press .

4. Select **Program shortcut keys** and then press **Start**.
5. Press the shortcut key you want to change, for example, **Hold/Save**.
6. If you want to replace the **Hold/Save** with the Alarm function, select **Alarm** with the arrow buttons and then press **Select**. To confirm your selection, press **Yes**. Otherwise press **No** and continue from step 4.
7. To return to the basic display, press **Exit**

Button Tones and Backlight

You can turn on or off the sound effects for the buttons and the back light. Follow the instructions below:

1. Open the menu by pressing **Open**.
2. Select **Settings** and press .
3. Select **User interface** and press .
4. To turn on or off the sound effect, select **Key Click** and then press **On/Off**.
5. To turn on or off the backlight, select **Backlight on key** and press **On/Off**.
6. To return to the basic display, press **Exit**.







Date and Time

As a default, the time format is based on the 12-hour clock. Also a 24-hour clock can be used.

The default date format is month.day.year. The date format can be changed to day.month.year. or year.month.day.

For correct time and date in the recorded data files, follow the instructions below:

1. Open the menu by pressing **Open**.
2. Select **Settings** and press .
3. Select **Date and time** and press .









4. For the desired date, select **Date** and then press  **Set**. Use the arrow buttons to change the date. Confirm the selection by pressing  **Select**. To change the date format, select from the alternatives and press  **Select**.
5. For the desired time, select **Time** and press  **Set**. Use the arrow buttons to change the time. To confirm the selection, press  **OK**. To change the time format, select **12-hour clock** and press  **On/Off**.
6. To return to the basic display, press  **Exit**.

Measurement Settings

There are no measurement setting available for modification on the DPL4000.







Device Information

Basic information about the indicator and the probe is found as follows:

1. Open the menu by pressing   **Open**.
2. Select  **Settings** and press .
3. Select **Device information** and press  **Show**.
4. The first display gives the information on the MI70 indicator. For details on the probe, press  **More** and then press  **OK**.
5. To return to the basic display, press  **Exit**.

Factory Settings

The factory settings can be restored to clear all the changed settings and data memory of the indicator. Restoring factory settings does not affect the probe calibration.

1. Open the menu by pressing   **Open**.
2. Select  **Settings** and press .
3. Select **Factory settings** and press  **Revert**. To confirm the selection, press  **Yes**. Power is turned off automatically.

When turning on DPL4000 again, the factory settings are restored. You will have to set the language, date, and time again.

REVISION HISTORY

Rev.	Description	Date	MCO #
-	First release		
A	Added part numbers	2/20/2019	2257
B	Added calibration interval text	3/25/2021	2308
C	Added calibration info re: display unit	12/14/2023	2346

Super Systems Inc.

USA Office

Corporate Headquarters:

7205 Edington Drive

Shipping Address:

7245 Edington Drive

Cincinnati, OH 45249

Phone: (513) 772-0060

<http://www.supersystems.com>

Super Systems Europe

Unit E, Tyburn Trading Estate,
Ashold Farm Road, Birmingham

B24 9QG

UNITED KINGDOM

Phone: +44 (0) 121 306 5180

<http://www.supersystemseurope.com>

Super Systems México

Sistemas Superiores Integrales S de RL de CV

Acceso IV No. 31 Int. H Parque Industrial

Benito Juarez

C.P. 76120 Queretaro, Qro.

Phone: +52 442 210 2459

<http://www.supersystems.com.mx>

Super Systems China

No. 369 XianXia Road

Room 703

Shanghai, CHINA

200336

Phone: +86 21 5206 5701/2

<http://www.supersystems.cn>

Super Systems India Pvt. Ltd.
A-26 Mezzanine Floor, FIEE Complex,
Okhla Indl. Area, Phase – 2
New Delhi, India 110 020
Phone: +91 11 41050097
<http://www.supersystemsindia.com>