



**SuperSystems**  
incorporated

NITRIDING CONTROL SYSTEM

MODEL 9210

# OPERATIONS MANUAL

**Super Systems Inc.**

7205 Edington Drive

Cincinnati, OH 45249

Ph: 513-772-0060

Fax: 513-772-9466

[www.supersystems.com](http://www.supersystems.com)



**Super Systems Inc.**

USA Office

*Corporate Headquarters:*

7205 Edington Drive

*Shipping Address:*

7245 Edington Drive

Cincinnati, OH 45249

Phone: (513) 772-0060

<http://www.supersystems.com>

**Super Systems Europe**

Unit E, Tyburn Trading Estate,

Ashold Farm Road, Birmingham

B24 9QG

UNITED KINGDOM

Phone: +44 (0) 121 306 5180

<http://www.supersystemseurope.com>

**Super Systems México**

Sistemas Superiores Integrales S de RL de CV

Acceso IV No. 31 Int. H Parque Industrial

Benito Juarez

C.P. 76120 Queretaro, Qro.

Phone: +52 442 210 2459

<http://www.supersystems.com.mx>

**Super Systems China**

No. 369 XianXia Road

Room 703

Shanghai, CHINA

200336

Phone: +86 21 5206 5701/2

<http://www.supersystems.cn>

**Super Systems India Pvt. Ltd.**

A-26 Mezzanine Floor, FIEE Complex,

Okhla Indl. Area, Phase – 2

New Delhi, India 110 020

Phone: +91 11 41050097

<http://www.supersystemsindia.com>

# Table of Contents

<b>TABLE OF CONTENTS.....</b>	<b>3</b>
<b>SAFETY.....</b>	<b>7</b>
<b>ABOUT THIS MANUAL.....</b>	<b>9</b>
<b>CONTROLLER DESCRIPTION .....</b>	<b>9</b>
<b>MODEL 9210 TERMINALS CONNECTIONS .....</b>	<b>10</b>
<b>ADDITIONAL FEATURES .....</b>	<b>11</b>
<b>ETHERNET CONNECTIONS .....</b>	<b>11</b>
<b>MECHANICAL INSTALLATION .....</b>	<b>11</b>
<b>ELECTRICAL INSTALLATION.....</b>	<b>12</b>
<b>INSTRUMENT START-UP.....</b>	<b>12</b>
<b>FLASH CARD &amp; FLASH CARD READER .....</b>	<b>12</b>
<b>CHAPTER 1 - INSTALLATION .....</b>	<b>14</b>
STAND-ALONE FLOW PANEL.....	14
MOUNTING THE TOUCHSCREEN INTERFACE .....	14
THE CONTROL ENCLOSURE.....	15
<b>CHAPTER 2 – TOUCH-SCREEN INTERFACE .....</b>	<b>16</b>
DISPLAY .....	16
LOOPS DISPLAY.....	17
TEMP DETAIL .....	17
FLOW DETAIL .....	18
MENU DISPLAY .....	18
MENUS .....	19
PROGRAM DISPLAY.....	21
CHART .....	22
DATA LOGGING USING FLASH CARD .....	22
<b>CHAPTER 3 - CONFIGURATION.....</b>	<b>24</b>
CONFIGURATION MENU .....	24
PROGRAM EDIT .....	24
AUXILIARY INSTRUMENTS.....	25
AUXILIARY ANALOG INPUT.....	25
SHUTDOWN (DISPLAY) .....	25
9210 DATE AND TIME.....	25
SLAVE COMMUNICATIONS STATUS.....	25
MANUAL EVENT CONTROL .....	26
PID LOOP SETUP .....	26
EVENT RUN PROGRAM SETUP.....	27
ZONE / LOAD TC SETUP .....	27

PORT SETUP .....	28
INSTRUMENT SETUP.....	28
ZONE ASSIGNMENTS.....	29
FURNACE SETUP.....	30
DEFAULT WAIT LIMITS.....	31
FURNACE NAME.....	31
ALARM SETUP.....	32
RELAY ASSIGNMENT.....	33
RELAY SET POINTS.....	33
ANALOG INPUT SETUP.....	33
ANALOG OUTPUT SETUP.....	34
PASSCODE AND ALARM.....	35
IP ADDRESS.....	36
EVENT CONTROL.....	36
VALVE CONFIGURATION.....	37
VALVE SETUP.....	37
USER CALIBRATION.....	38
FULL CALIBRATION.....	40
SET MENU SECURITY.....	40
READ/WRITE RAW DATA.....	41
CURVE ENTRY.....	41
ALTERNATE PID SETUP.....	41
ANALOG INPUT BOARD SETUP.....	41
PLC CALIBRATION.....	41
ADAM CORRECTION.....	42
AUX SP CONFIGURATION.....	42
TUNING ASSISTANT.....	43
DF1 CONFIGURATION.....	44
<b>CHAPTER 4 – CONFIGURATOR 2.0 MENUS.....</b>	<b>46</b>
(MENU).....	46
SLAVE INSTRUMENTS.....	48
AUXILIARY ANALOG INPUT.....	48
MANUAL EVENT CONTROL.....	49
PID LOOP SETUP.....	50
EVENT RUN PROGRAM SETUP.....	53
ZONE/LOAD TC SETUP.....	54
PORT SETUP.....	54
SLAVE INSTRUMENT SETUP.....	55
ZONE ASSIGNMENTS.....	57
FURNACE SETUP.....	58
DEFAULT WAIT LIMITS.....	60
FURNACE NAME.....	60
ALARM SETUP.....	60
RELAY ASSIGNMENTS.....	63
RELAY SETPOINTS.....	64
ANALOG INPUT SETUP.....	65
ANALOG OUTPUT SETUP.....	68
PASSCODE AND ALARM.....	69
IP ADDRESS.....	70
EVENT CONTROL.....	70
VALVE CONFIGURATION.....	71

VALVE SETUP .....	72
SET MENU SECURITY.....	73
CURVE ENTRY .....	74
ALTERNATE PID SETUP.....	75
SSI ANALOG INPUT SETUP.....	75
SSI CONFIGURATION AND CALIBRATION .....	76
<i>Overview</i> .....	76
<i>Equipment needed</i> .....	76
<i>Notes</i> .....	76
<i>User Calibration</i> .....	77
<i>Full Calibration</i> .....	78
ADAM MODULE OFFSET CORRECTION.....	79
AUX SETPOINT CONFIGURATION.....	80
TC EXTENSION CORRECTION CURVES .....	80
TUNING ASSISTANT .....	81
DF1 CONFIGURATION.....	82
<b>CHAPTER 5 - PROGRAMS.....</b>	<b>83</b>
OVERVIEW .....	83
PROGRAM EDITING .....	83
<b>CHAPTER 6 - SERIES 9210 OPCODES.....</b>	<b>85</b>
PROGRAMMER DESCRIPTION.....	85
OPCODES .....	85
<b>CHAPTER 7 - APPLICATIONS INFORMATION .....</b>	<b>93</b>
STANDARD EVENT ASSIGNMENTS.....	93
NITRIDING RECIPES/PROGRAMS .....	93
SAMPLE RECIPES .....	93
FLOW SECTION.....	95
<b>SUPER SYSTEMS NITRIDING SAMPLE CELL .....</b>	<b>99</b>
1.0 INTRODUCTION .....	99
1.1 APPLICATIONS.....	99
1.2 SYSTEM DESCRIPTION .....	99
1.3 SYSTEM HIGHLIGHTS .....	99
1.4 UNPACKING AND VISUAL CHECKING .....	99
2.0 SPECIFICATION .....	100
2.1 ENCLOSURE - NA.....	100
2.2 DIMENSIONS .....	100
2.3 AMBIENT TEMPERATURE.....	100
2.4 DISPLAY - NA.....	100
2.5 ANALOG OUTPUTS – ISOLATED (OPTIONAL) .....	100
2.6 ALARM INDICATORS (OPTIONAL).....	100
2.7 COMMUNICATIONS RS232.....	100
2.8 SPEED OF RESPONSE.....	101
2.9 POWER REQUIREMENTS.....	101
2.10 GAS CONNECTION .....	101
4.0 CALIBRATION .....	102
4.1 GENERAL FREQUENCY .....	102
4.2 CALIBRATION METHOD .....	102
5.0 TECHNICAL INFORMATION .....	103

6.0	SERVICING .....	103
<b>APPENDIX 1</b>	<b>.....</b>	<b>104</b>
1.1	COMMUNICATIONS PROTOCOLS.....	104
1.2	RS232 COMMAND COMMUNICATIONS. ....	104
<b>NITRIDING SAMPLE CELL CLEANING</b>	<b>.....</b>	<b>107</b>
<b>APPENDIX 2 - TC TYPE MV RANGE CHART</b>	<b>.....</b>	<b>108</b>
<b>APPENDIX 3 – CHANGING THE DATE/TIME OF THE TOUCH SCREEN DISPLAY</b>	<b>.....</b>	<b>109</b>
<b>APPENDIX 4 – CALIBRATION OF SSI ANALOG INPUT BOARDS</b>	<b>.....</b>	<b>110</b>
<b>APPENDIX 5 – 9210 NITRIDER TYPICAL CONFIGURATION</b>	<b>.....</b>	<b>113</b>
<b>REVISION HISTORY</b>	<b>.....</b>	<b>121</b>

## Safety

- *Safety Symbols* - Various symbols are used on the instrument, they have the following meaning:



Caution (refer to the accompanying documents)



Functional earth (ground) terminal

The functional earth connection is required for safety purposes and to ground RFI filters.

- *Personnel* - Installation must only be carried out by technically qualified personnel.
- *Enclosure of live parts* - To prevent hands or metal tools from touching parts that may be electrically live (powered), the controller must be installed in an enclosure.



- *Caution: Live sensors* - Do not connect live (powered) sensors to any signal input on the controller. Live sensors are sensors that must be connected to the main's supply. The controller has transient protection circuits connected between the inputs and the earth connection, which might be damaged by live (powered) sensors.
- *Wiring* - It is important to connect the controller in accordance with the wiring data given in this handbook. Take particular care not to connect AC supplies to the low voltage sensor input or other low level inputs and outputs. Only use copper conductors for connections (except thermocouple inputs) and ensure that the wiring of installations comply with all local wiring regulations. For example in the United Kingdom use the latest version of the IEE wiring regulations, (BS7671). In the USA use NEC Class 1 wiring methods.
- *Power Isolation* - The installation must include a power isolating switch or circuit breaker. This device should be in close proximity to the controller, within easy reach of the operator and marked as the disconnecting device for the instrument.
- *Earth leakage current* - Due to RFI Filtering there is an earth leakage current of less than 0.5mA. This may affect the design of an installation of multiple controllers protected by Residual Current Device, (RCD) or Ground Fault Detector, (GFD) type circuit breakers.
- *Over current protection* - To protect the internal PCB tracking within the controller against excess currents, the AC power supply to the controller and power outputs must be wired through a fuse or circuit breaker specified in the technical specification.
- *Voltage rating* - The maximum continuous voltage applied between any of the following terminals must not exceed 264VAC:
  - line or neutral to any other connection
  - relay or triac output to logic, DC or sensor connections
  - any connection to ground



The power supply/controller should not be wired to a three phase supply with an unearthed star connection. Under fault conditions such a supply could rise above 264Vac with respect to ground and the product would not be safe.

Voltage transients across the power supply connections, and between the power supply and ground, must not exceed 2.5kV. Where occasional voltage transients over 2.5kV are expected or measured, the power installation to both the instrument supply and load circuits should include a transient limiting device. These units will typically include gas discharge tubes and metal oxide varistors that limit and control voltage transients on the supply line due to lightning strikes or inductive load switching. Devices are available in a range of energy ratings and should be selected to suit conditions at the installation.

- *Conductive pollution* - Electrically conductive pollution must be excluded from the cabinet in which the controller is mounted. For example, carbon dust is a form of electrically conductive pollution. To secure a suitable atmosphere in conditions of conductive pollution, fit an air filter to the air intake of the cabinet. Where condensation is likely, for example at low temperatures, include a thermostatically controlled heater in the cabinet.
- *Over-temperature protection* - When designing any control system it is essential to consider what will happen if any part of the system should fail. In temperature control applications the primary danger is that the heating will remain constantly on. Apart from spoiling the product, this could damage any process machinery being controlled or even cause a fire. Reasons why the heating might remain constantly on include:
  - the temperature sensor becoming detached from the process
  - thermocouple wiring becoming a short circuit
  - the controller failing with its heating output constantly on
  - an external valve or contactor sticking in the heating condition
  - the controller setpoint set too high

Where damage or injury is possible, we recommend fitting a separate over-temperature protection unit, with an independent temperature sensor, which will isolate the heating circuit. Please note that the alarm relays within the controller will not give protection under all failure conditions.

- *Grounding of the temperature sensor shield* - In some installations it is common practice to replace the temperature sensor while the controller is still powered up. Under these conditions, as additional protection against electric shock, we recommend that the shield of the temperature sensor be grounded. Do not rely on grounding through the framework of the machine.
- *Installation requirements for EMC* - To ensure compliance with the European EMC directive certain installation precautions are necessary. When using relay or triac outputs it may be necessary to fit a filter suitable for suppressing the emissions. The filter requirements will depend on the type of load. For typical applications we recommend Schaffner FN321 or FN612.
- *Routing of wires* - To minimize the pick-up of electrical noise, the wiring for low voltage DC and particularly the sensor input should be routed away from high-current power cables. Where it is impractical to do this, use shielded cables with the shield grounded at one end.

## About This Manual

This instrument is designed for Nitriding control and configured per individual customer requirements. This manual covers the operation of the Model 9210 Nitriding Controller, the Nitriding Control System and the Gas Flow Panel.

## Controller Description

The Model 9210-Nitriding instrument is a multi-loop Proportional Integral Derivative (PID) controller that can be custom configured to control up to three Nitriding process loops. General features of this product include:

The Model 9210 is powered by 24 VDC, **NOT LINE** Voltage. Please be careful when connecting power to this controller. Connecting anything other than 24 VDC will cause serious damage.



Approximate Box Dimensions	2.75" x 4" x 4.5"
Power Requirements	24VDC, 4 Watts
Temperature Range	32°F - 132°F
Digital Output Rating	300VAC / 1 AMP
Analog Output Load Rating	1000 Ohms (Total)
Controller Enclosure Rating	IP10 - hand protected
Number of RS232 Ports	Two (2)
Number of Ethernet Ports	One (1)
Number of RS485 Host Ports	One (1)
Number of RS485 Slave Ports	Two (2)
Number of Internal Relays	Eight (8)
Number of Analog Inputs	Three (3)
Number of Analog Outputs	Two (2)
Number of Digital Inputs	Four (4)
Number of Control Loops	Three (3)

The control enclosure is powered by 120 VAC, Single Phase, 60 Hz (Line Power). Line voltage for the isolation relays comes from the same source.

Model 9210 Terminals Connections

SUPER SYSTEMS INC. (800) 666-4330 www.supersystems.com		
1 - 24VDC (COM)	12 - RELAY OUT 5	22 - SLAVE 2 RS485 (+)
2 - 24VDC (+)	13 - RELAY OUT 6	23 - SLAVE 2 RS485 (-)
3 - RS485 RT (-)	14 - RELAY OUT 7	24 - 4-20mA OUT 1 (-)
4 - RS485 RT (+)	15 - RELAY OUT 8 NC	25 - 4-20mA OUT COM (+)
5 - SLAVE 1 RS485 (-)	16 - RELAY OUT 8 NO	26 - 4-20mA OUT 2 (-)
6 - SLAVE 1 RS485 (+)	17 - DIGITAL IN 1	27 - ANALOG IN 3 (-)
7 - RELAY COMMON	18 - DIGITAL IN 2	28 - ANALOG IN 3 (+)
8 - RELAY OUT 1	19 - DIGITAL IN 3	29 - ANALOG IN 2 (-)
9 - RELAY OUT 2	20 - DIGITAL IN 4	30 - ANALOG IN 2 (+)
10 - RELAY OUT 3	21 - DIGITAL IN COM	31 - ANALOG IN 1 (-)
11 - RELAY OUT 4		32 - ANALOG IN 1 (+)

*Note: See electrical drawings for terminal block assignments.*

## Additional Features

The Operator Interface (touch screen) contains a removable compact flash card that can be used to transfer data from the Model 9210 to a computer. This flash card acts like a removable hard drive, however it is very small and contains no moving parts to make it very portable. It is located on the back of the display (see *Flash Card Installation* on page #8).

Also included is a "Utility Software CD" that includes SSI's Super Data (SD) Recorder. SD Recorder is a utility program that can be loaded onto any Windows® based computer (operating Windows 98® or higher). This software will allow the computer to read the data from the Model 9210, and allow it to be charted in a manner that is similar to a strip chart recorder.

The Operator Interface is normally accessed via the touch-screen, however connections also exist that will allow the operator to use a traditional mouse and keyboard to enter information.

## Ethernet Connections

The Ethernet connection has two distinct uses. The first is, should the Operator Interface fail, it allows a laptop to be connected to the Series 9210 DIN rail mounted unit. This connection can act as a LIMITED FUNCTION "operator interface" until the Operator Interface can be repaired or replaced. The laptop needs to be operating a WINDOWS 98® or higher with Internet Explorer. The default IP address is **192.168.0.200**. If you are experiencing problems please call **513-772-0060** and talk with our computer communications personnel. The second use for the Ethernet port would be for communications to a SCADA software package. Call us at **513-772-0060** if you are interested in this option.

## Mechanical Installation

The Model 9210 operator interface is generally flush-mounted, either in an existing enclosure, on a "plate" that will be retrofitted to an existing enclosure, or on a new enclosure specifically designed for it's particular application. Installation begins by securing the new enclosure to the floor or wall, securing the retrofit plate to the door of the existing enclosure, or flush-mounting the operator interface in a cut-out of the existing enclosure. When tightening the retaining clips on the Operator Interface, it is important to make them snug but not to over-tighten them. Over-tightening can warp the bezel and cause irreparable damage to the Operator Interface. The DIN rail mount portion of the controller (the Model 9210 and the 24 VDC power supply) needs to be located in close proximity to the existing wires that were connected to the older control unit being replaced. These units should be secured prior to making any electrical connections.

## Electrical Installation

The Model 9210 requires 24VDC, 4 Watt, 60 Hz, single-phase power. A 24 VDC power supply is required and is generally included as part of the Model 9210 system. This power supply has a universal input that can accept between 60 and 265VAC. Power should be applied in accordance with the electrical drawings that have been supplied. Since each installation is unique for each site, the customer is responsible for providing adequate power and making it available to the Model 9210 power supply.

## SSi requirement:

MOV's must be wired across the isolation relay coil terminals on all isolation relays that are connected to solenoids. **Further....** MOV's must be connected across the HOT and NEUTRAL wires when the solenoid is wired to them. **IT IS AN ABSOLUTE MUST to have the MOV's at BOTH LOCATIONS.**

### Instrument Start-up

On power-up, the Operator Interface will display a logo screen for thirty seconds and then switch to the default status screen. The logo display can be terminated early by touching the screen.

### Flash Card & Flash Card Reader

*Never remove the flash card when the Operator Interface is ON.*

To properly shut down the Operator Interface, press the **Menu** button, and select *Shutdown*. At the prompt, press **Yes** to shut down the operator interface. This will bring you to a conventional Microsoft Windows screen. Sliding the black switch (located directly over the green power connector) to the operator interface to the OFF position will turn off the power.

Once the Operator Interface is turned off, remove the compact flash card cover at the top of the display unit, exposing the card. Press the release button and the card will pop out of the slot. To replace the flash card simply return the card to the slot, making sure that the release button is in it's up position, and replace the flash card cover to it's proper position. To restore power to the unit, move the black switch to the right or ON position.

A typical Nitriding Control system consists of two panels, a Control Enclosure and a Flow Panel. The variety of input and output combinations available with this system allows SSi to configure the Model 9210-Nitrider to control **Nitriding** (temperature, % dissociation, and back-pressure) or just to monitor % Dissociation.

The Control Enclosure contains a 24 VDC power supply, SSi's Model 9210 Controller, flush-mounted operator interface (Advantech touch-screen), an Allen Bradley Micrologix 1200 PLC, a ring-back alarm system with enunciator, terminal blocks, isolation relays, a hi-limit temperature controller and a UPS unit. The Model 9210 has several control outputs, allowing the customer to choose what variables to control, and how to control them. The 9210 is also used as a recipe programmer to control the furnace cycle from startup to cool down. The operator interface allows the operator to interface with the Model 9210 to view/modify Process Loops, Program status and to modify operating parameters as necessary. The operator interface also contains a Flash card that is used as to datalog Furnace parameters and provides the capability to transfer historical data from the Flash card to any PC that has the SDRRecorder Utility software installed. The Micrologix 1200 is used in conjunction with the 9210 for alarm and event handling purposes. The Hi-Limit controller provides furnace over-temperature protection. The UPS Unit provides

Battery backup and surge protection for the 120Vac that is used to power the 9210's 24Vdc power supply and the Micrologix PLC .

The UPS will provide up to 15 minutes of power in case of power loss. To properly shutdown the Nitriding panel ...SHUTDOWN the ADVANTECH screen (see instructions), then open panel door and turn OFF UPS. The panel is now safe for electrical work.

There are **NO implied safety devices** included with this control system.

**The safety system (atmosphere flow and pressure) is the responsibility of the customer.**

**Stand-alone Flow Panel** includes the atmosphere flow sample enclosure, the flow switches, back-pressure control (if part of the system), the flow control devices, and the pressure switches. The Flow panel is interconnected with the Control panel to allow the Nitriding Control system to provide control of Gas flows, the furnace's back-pressure and monitoring of supply and exhaust pressures for alarming. The flow panel is designed to supply up to four different gases to the furnaces. Typical gases used are Nitrogen, Ammonia, Dissociated Ammonia and Hydrogen.

### **Nitriding Control System: Mode of Operation**

A typical 9210 Nitriding Control system allows the user to automatically run the Nitriding cycle without requiring operator intervention. The system will set temperature, % Dissociation/Kn, Back Pressure and Gas Flows as part of it's recipe. To control the % Dissociation/Kn, the 9210 has the ability to adjust the Gas flows at any step of the process. Typically, the Ammonia flow rate is adjusted to achieve the desired % Dissociation/Kn. This adjustment uses the Trim Enable and Trim Range variables. These variables can be set by the recipe or manually from the Detail screen. Trim Enable determines whether the Gas flow can be adjusted. Trim Range is a +/- band from setpoint that the Gas Flow setpoint can be adjusted to. For example, Ammonia Flow Setpoint = 50, Ammonia Trim Enable = Yes and Trim Range = 20. With these settings the Ammonia Flow setpoint can be adjusted from 30 up to 70. The amount of adjustment is determined by the % Dissociation/Kn control loop. If the % Dissociation/Kn requires more ammonia the setpoint is increased, if less ammonia is required, the ammonia flow setpoint is decreased.

## Chapter 1 - INSTALLATION

### Stand-alone Flow Panel

The flow panel needs to be mounted in a manner that allows the panel to function as designed. The flow panel should be physically mounted close to the nitriding furnace. The gas inlets and outlets must be situated so that all of the connections can be made. Power comes from the control enclosure. The shortest sample line will allow for easy maintenance should there be a problem.

The gas sample from the nitriding furnace needs to be connected to the exhaust line of the flow panel. This allows for control of the furnace's backpressure as well as providing gas flow for the Sample Box. The connection point is at the "T" fitting located on the bottom of the flow panel. All connection with the flow panel need to be tight, remember that there is ammonia gas in the sample line.

**NOTE:** All exhaust gases should be disposed of according to local regulations.

**NOTE:** DO NOT USE ANY OF THE FOLLOWING TYPE OF PIPING OR CONNECTORS WITH THE FLOW PANEL:

1. Copper
2. Brass
3. Galvanized Steel
4. Aluminum

SOME METALS REACT WITH AMMONIA AND CAN PRODUCE LEAKS OVER TIME!!!  
USE SCHEDULE 80 PIPING AND FITTINGS ON ANY LINE THAT WILL HAVE AMMONIA OR DISSOCIATED AMMONIA FLOWING THROUGH IT.

### Mounting the Touchscreen Interface

1. There is an adhesive waterproof gasket on the front bezel. Ensure that the waterproof gasket is in place before installing the TPC system in the panel opening.
2. Install the TPC in the panel opening.
3. Retrieve the clamps and long screws from the accessory pack. Hook the clamps the holes located on the four sides of the bezel. Insert screws into every clamp and tighten them to fasten the clamp in place. These screws will push against the mounting panel and secure the unit.
4. The suggested mounting panel thickness is less than 6 mm (0.236 in).
5. The suggested mounting screw torque is 2 KGF-cm (kilogram-force centimeter) or 0.14 ft\*lb (foot pound)  
(Finger tight + ¼ turn + removable Loctite)

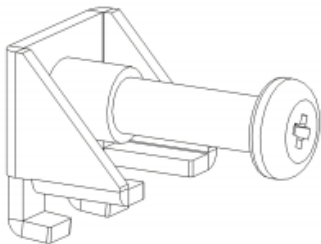

Insert the screws into each clamp and tighten them to fasten the clamp in place.

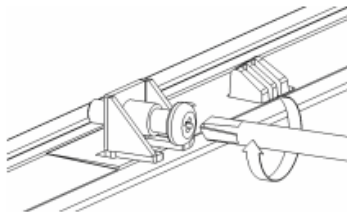

Hook the clamps into the holes and fasten the screws  
Torque: 2 kgf-cm  
These screws will push the mounting panel and secure the unit.

### The Control Enclosure

This unit needs to be mounted less than 50 feet from the flow panel. Communications between the **Flow Panel's Sample Unit** and the **Control Enclosure** use RS232, which has a 50-foot maximum distance requirement.

---



## Chapter 2 – Touch-screen Interface

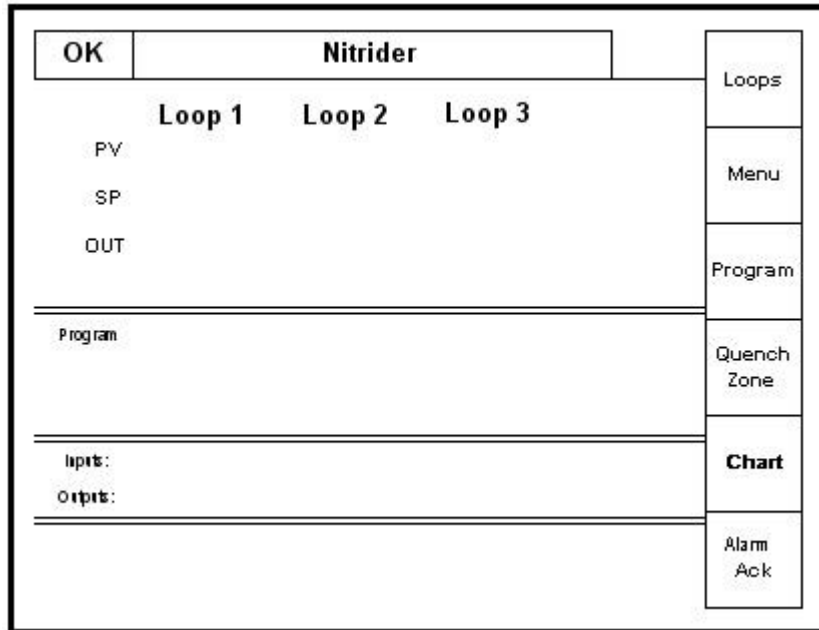

Default status screen

### Display

The *Status* display shows the controller information. This information includes data for Loop 1, Loop2 and Loop 3, as well as data for up to four (4) gas flowmeters. The Status display also shows the current Program status, Input/Output Events status and alarm indication. There are six active buttons on the left side of the status display screen: **Loops**, **Menu**, **Program**, **Quench Zone**, **Chart** and **Alarm Ack**.

- The “Loops” button will switch the display to the parameters for the active control loops, up to nine parameters. The buttons on the right side of the operator interface allows the operator to look at the “detail” for the loop designated.
- The “Menu” button will switch to the operator menu. The “blue” UP and DOWN arrow keys move you from one selection to another.
- The “Program” button will switch to the program display. This is a companion display to the status screen and is described below.
- The “Quench Zone” button (generally NOT used with the Nitriding Process) will switch to the Quench and Zone display. This is a companion display to the status screen and is described below.
- The “Chart” button will switch the display to the video recorder display. Use of the “Chart” display is explained below.
- The “Alarm Ack” button will switch to the Active Alarms screen. All Active alarms are displayed on this screen. To acknowledge an alarm, press the UP or DOWN arrow keys to highlight the alarm and press the “Ack” button, located in the lower left side of the screen, to acknowledge the alarm. To acknowledge multiple alarms, repeat the process just described. Return to the Status screen by pressing the “Esc” button.

### Loops Display

The current process variable for the active loops is displayed on the left. The setpoint for each parameter is to the right of the process variable, with the % control output to the right of the setpoint column.

Parm	PV	SP	OUT	
Temp				Temp Detail
Dissoc				Dissoc Detail
<b>Kn</b>				NH3 Detail
NH3				H2 Detail
<b>H2</b>				BP Detail
BP				DA Detail
DA				AUX Detail
AUX				AUX Detail
<b>O2</b>				AUX Detail
<b>H2</b>				AUX Detail
PROGRAM				STATUS

The "loops" screen also allows you to move back to the default "Status" screen. By pressing the "status" button on the bottom right-hand side of the operator interface. Pressing the Program button will open the "Program" screen.

### Temp Detail

This screen is activated by pressing the **Temp Detail** button on the Loops Display screen.

The operator can change the temperature setpoint by touching the temperature setpoint on the screen next to the words "Setpoint". When pressing the setpoint box, a numeric keypad is displayed, showing the current value and allowing you to enter a new setpoint by simply pressing on the appropriate numeric keys. Once the correct setpoint has been entered, press the **Enter** key to make the change. When the **Enter** key is pressed, the display returns to the "Temperature Detail" screen. The other active buttons - **Auto/Manual** and **Output** - are used in the same way. Pressing the **Auto/Manual** button will cycle the controller mode between auto and manual. Depending on the current Login, the screen may prompt for the Supervisor or Administrator password before the mode can be changed. Pressing the **Output** button displays an alphanumeric keypad that allows the operator to change the % Output (as long as the controller mode as been changed to manual. Entering the % output (while in manual mode) changes the % control output. This is especially useful when setting the linkage on motors, or testing the range of motion of an electric actuator.

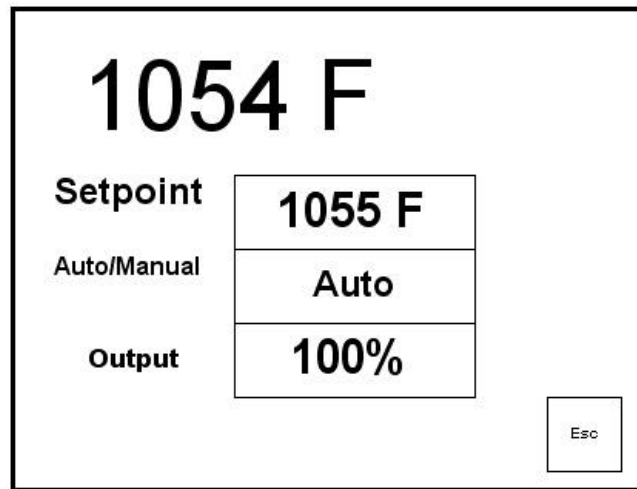

The Temp, % Dissociation and Back Pressure detail screens are used in the manner discussed above.

## Flow Detail

The screenshot shows a control interface for flow details. At the top, the current flow is displayed as **50.0 scfh**. Below this, there are three rows of data: **Flow Setpoint** with a value of **50.0** and a maximum of **MAX: 110.0**; **Trim Enable** set to **NO**; and **Trim Range** set to **20.0 SCFH**. To the right of these data fields are two buttons: **Close Valve** and **Esc**.

This screen is displayed by pressing the **NH3 Detail** button.

The operator can change the gas flow setpoint by touching the setpoint on the screen next to the words "Flow Setpoint". When pressing the setpoint box, a numeric keypad is displayed, showing the current value and allowing you to enter a new setpoint by simply pressing on the appropriate numeric keys. Once the correct setpoint has been entered, press the **Enter** key to make the change. When the **Enter** key is pressed, the display returns to the "NH3 detail" screen. The other active buttons - **Trim Enable** and **Trim Range** - are used in the same way. Pressing the **Trim Enable** button allows the user to enable or disable trim

adjustment of the gas flow. Depending on the current Login, the screen may prompt for the Supervisor or Administrator password before the Trim mode can be changed. Pressing the **Trim Range** button displays an alphanumeric keypad that allows the operator to change the trim range.

The flow detail screen has a **Close Valve** button that allows you to manually close the flow valve. Pressing the Close Valve button sets the Flow setpoint to zero (0) and causes the valve to drive close for two minutes.

The NH3, N2, DA, and AUX detail screens are used in the manner discussed above.

## Menu Display

The items listed under Menu display are:

- Program Edit
- Auxiliary Instruments
- Auxiliary Analog Input
- Shutdown
- 9210 Date and Time
- Slave Communications Status
- Manual Event Control
- PID Loop Setup
- Event Run Program Setup
- Zone/Load TC Setup
- Port Setup
- Instrument Setup
- Zone Assignments
- Furnace Setup
- Default Wait Limits
- Furnace Name
- Alarm Setup
- Relay Assignments
- Relay Setpoints
- Analog Input Setup
- Analog Output Setup
- Passcode and Alarm
- IP Address
- Event Control

The screenshot shows a menu display with a list of items on the left and navigation controls on the right. The list includes: Program Edit, Auxiliary Instruments, Auxiliary Analog Input, Shutdown, 9210 Date and Time, Slave Communications Status, Manual Event Control, PID Loop Setup, Event Run Program Setup, Zone/Load TC Setup, Port Setup, Instrument Setup, Zone Assignments, Furnace Setup, and Default Wait Limits. The navigation controls on the right consist of a vertical bar with a downward arrow at the top, an upward arrow, an **Enter** button, a downward arrow, a **Login** button, and an **Esc** button at the bottom.

- Valve Configuration
- Valve Setup
- User Calibration
- Full Calibration
- Set Menu Security
- Read/Write Raw Data
- Curve Entry
- Alternate PID Setup
- Analog Input Board Setup
- PLC Calibration
- ADAM Correction
- AUX SP Configuration

## Menus

There are four levels of menus in the Series 9210.

- The first level is the operator level. These are functions or operations that are typically handled by the furnace operator. This menu is accessed without the need for a pass code.
- The second level is to be used by a supervisor. This level requires entry of the level 1 or level 2 pass code.
- The third level is the Administrator level. This requires the level 2 pass code ONLY.
- The fourth level is the SSi level. This requires a special passcode that can only be obtained by calling SSi at 513-772-0060. These menus are used for configuration setups prior to the instrument being shipped.

As shipped, the level 1 and level 2 codes are set as **1** and **2** respectively. The pass codes can be changed under the *Passcode and Alarm* menu option.

The Menu screen has five operating buttons located on the right side of the screen. The Up arrow moves the cursor from bottom to top. The **Enter** button activates the highlighted selection that the operator has chosen, the Down arrow key moves the cursor from top to bottom, the **Login** key activates another screen that allows access to the user to enter a passcode to set the user level, and the **Esc** key takes you back to the previous screen without any action being taken.

The selections on the menu that are generally used by the furnace operator are:

- Program Run
- Slave Communications Status.
- Manual Event Control.
- Zone/Load TC Setup.
- Shutdown

The Program Run screen allows the operator to start/stop/hold/continue recipes, as well as adjust soak time values.

The Slave Communications Status allows the operator to view the communications status with slave instruments.

The Manual Event Control page allows the operator to turn on Output events in place of running a recipe to turn the Event on.

The Zone/Load TC Setup page allows the operator to select the thermocouples to use in the recipe for guaranteeing the Furnace temperature.

The Shutdown selection allows for the Advantech display to be turned off. The "Do you want to Shutdown the Model 9210 " screen pops up when you press the "shutdown" key. Two responses are possible "Yes" or "No". When you shut-down the ADVANTECH interface, the SERIES 9210 controller is still functioning. You can monitor it by connecting the ETHERNET connection to a laptop computer, using Internet Explorer, and assigning a legitimate IP address.

***NOTE:*** Shutting down the ADVANTECH (Operator Interface) does not "turn-off" the Series 9210. The "shut-down" procedure must be done to remove the "flashcard".

"Yes" shows you a typical computer screen with the "start" button in the bottom left-hand corner. You can now turn the power off to the operator interface without upsetting any of the settings. The "No" response returns you to the initial status screen.

## Program Display

Pressing the **Program** key displays the default program status page.

This screen displays the following information:

- Program No. – the last program number loaded into the program run buffer.
- Status – Displays if the program is running, in hold or stopped.
- Remaining Time Step – Time remaining in the current step
- Total – Total run time of the current program
- Program listing – displays all 24 steps for the program. If the program is running the active step number is highlighted.

OK		Nitriding				Soak Adjust
Program 1		Status: Stopped		0:00		
Remaining Time		Step: 0:00		Total: 0:00		Load
Step	Opcode	Temp	Atm	Option		Stop
1	GOSUB			50		
2	GOSUB			51		
3	VALVE_SET	100	20	Ammonia		Hold
4	SETPT		12.0			
5	SOAK			2:00		
6	VALVE_SET	50	25	Ammonia		Cont
7	SETPT		25.0			
8	SOAK			8:00		Alm Ack
9	EVT_OUT			3 -ON		
10	VALVE_SET	100		Nitrogen		
11	VALVE_SET	0		Ammonia		
12	JUMP			60		Esc

**NOTE:** See "Sample Recipes" at the back of this manual for Recipes "50", "51" and "60".

The Program display has six active buttons located on the right-side of the display. These are activated by touching the inside of the blocks. The active buttons are: **Soak Adjust**, **Load**, **Stop**, **Hold**, **Cont**, **Alm Ack (Alarm Acknowledge)** and **Esc**.

- The **Soak Adjust** button allows you to enter a new value for the time remaining in the current soak cycle. A soak cycle must be running for a change in soak time to be adjusted.
- The **Load** button allows the operator to enter the recipe number to be run and to view the recipe before pushing the **Run** button. Pushing the **Run** button starts the recipe. If a recipe program is running and the operator enters a new recipe program, it can be viewed and modified. The recipe does not become active until the **Run** button is pushed. Pressing **Run** places the program currently being viewed in the active memory and will begin to run the new recipe. You can start the program in any step simply by moving the highlight down to the step that that the program needs to be started in, and then pressing the **Run** button.

While reviewing the program that is about to be run, certain parameters within those steps can be modified. You can change the set points, the time and the options. You CANNOT delete a step, or modify its Op Code.

- The **Stop** button stops the recipe program that is currently running. Stop means exactly that. It stops the program. It is NOT a hold button. See **Hold** below. To re-start the program if it has been stopped, you must use the **Load** button, enter the recipe number, and then enter the segment number of the recipe that you want to start with.
- The **Hold** button places the displayed recipe program in "hold". Once a decision is made that affects the recipe it may be continued by pressing the **Cont** button.
- The **Cont** button re-starts the displayed (active) recipe only after it has been placed in **Hold**.

- The **Alm Ack** acknowledges any active alarm, in most cases it will be acknowledging *End of Cycle*. The alarm must be acknowledged to allow the program to go to the next step, turning EVENT 1 (End of Soak) Off, and stopping the program.
- The **Esc** button returns you to the default display screen.

## Chart

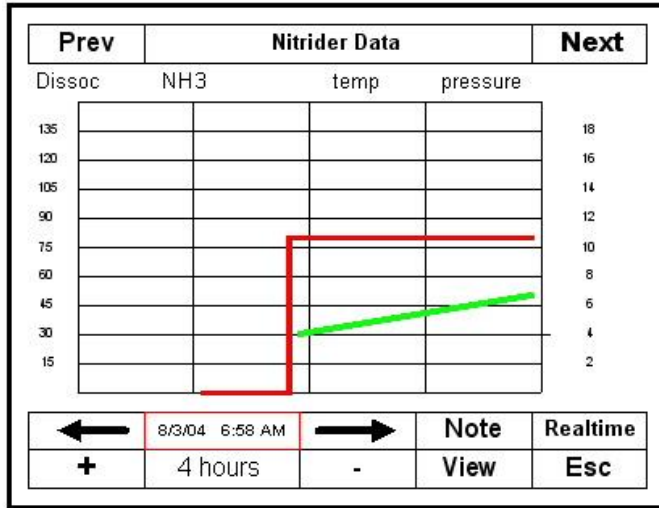

The Chart display shows between 15 minutes and 7 days of process variable data on the screen, and can be scrolled back to view all of the data stored on the hard drive (72 hours at a time). The vertical timelines change as the time changes on the screen. A chart is available for the "LP1 and LP2" only and a chart is available for the "LP1 and LP2 plus their setpoints". You can toggle between the two charts by pressing the **Prev** and **Next** keys. Note that LP1 relates to %Dissociation/Kn and LP2 relates to the Furnace Temperature.

The **Prev** and **Next** buttons change the display from one chart to another (i.e. from just process variables to process variables and setpoints.)

The blue Right and Left arrow buttons move the displayed chart along the horizontal axis, going back and forward in time and then returning to real time.

The **+** and **-** buttons change the time window displayed on the screen.

The **Note** key allows the operator to enter a note on the chart, similar to writing on a paper chart. The note shows up when the chart is printed out using the utility software included with the Series 9200 instrumentation. The interface must be the Advantech 5.7 inch with the flash card.

Pressing the **Note** button displays an alpha/numeric keypad. Pressing the **Edit** button will allow the operator to enter the ID/initials. Pressing the **<- Enter** button will set the entered text. Pressing the next **Edit** button will allow the operator to enter the note. The operator can also determine where the note will be written. The default choice is the current time and date. You can change the parameters and place the note at whatever time and date is required. Pressing the **Save** button takes you back to the real time chart page.

The **View** key allows you to look at the notes that have been stored with the chart.

The **Realtime** button will place the chart in realtime mode. Pressing the left or right arrows will take the chart out of realtime.

The **Esc** button will return the operator to the main display screen.

## Alarm Ack

The **Alarm Ack** button opens the Active Alarms screen and allows the operator to acknowledge any alarms that have been configured, or that have been made part of the recipes that run on the Series 9210. If a recipe has an alarm as a step, the alarm must be acknowledged before the recipe will continue from that particular step.

## Data Logging using Flash Card

The Advantech TPC-642S/642-SE touch screen operator interface utilizing a Compact Flash card allows the unit to data log the parameters setup by a qualified SSi technician. Should a customer not take the data offline in a timely manner, the data will be over-written, the oldest data being that which is over-written first. The following is a description on how this data log system works:

1. When the Advantech operator interface detects that there is less than 5% disk space left on the Compact Flash card, an alarm will be displayed on the main interface screen stating "x% disk space remaining (overwrite at 3%)". In the upper right corner, an ALM is indicated, but because it is not a communications alarm or a 9210 device alarm, the background remains green. This alarm will remain active until more than 5% of disk space is available for writing data log files.
2. If the user does not copy the log data from the disk, it will eventually fall to 2% disk space. At this point, the touch screen will select the oldest compressed file and delete it. It then checks to see if 3% remains. It repeats this procedure until 3% disk space remains. At this point the alarm message changes to "Overwriting data log data!". Because this allows the system to seesaw between 2% and 3%, it will continue to display "Overwriting data log data!" until somebody offloads the files.

Technical concerns and details:

1. If there are not enough compressed files to bring the free space up to 3%, the system will hunt down and kill hourly files. This should only happen if compression would not be running for some reason.
2. If all compressed files and hourly files have been removed and there is still not enough disk space (perhaps a problem with the Compact Flash card), the data logger will not write to the disk until the condition is remedied. (Alarms continues to display)
3. The data log data alarm is the lowest priority. The alarm priorities are touch-screen communications, then 9210 controller/programmer, then disk space.



**Warning: Make sure that the 9210 application has been shut down before removing the flash card**



## Chapter 3 - CONFIGURATION

### Configuration Menu

The Configuration Menu is entered through the **Menu** button that is part of the 6 buttons running down the right side of the default status display screen. Pressing the **Login** button that is below the blue Up and Down arrow buttons displays a numeric keypad. Enter the correct passcode for the configuration level and press the **Enter** key. This displays the configuration menu.

### Program Edit

Selecting *Program Edit* displays another screen, which asks the operator to enter a program number to be edited. Enter **0** to edit a blank program. To erase/delete an existing recipe/program you need to save it as Program Zero (0). Program 0 is a "NO-OP" program. Depending on the 9210's security setup and current Login status, the user may be first prompted to enter a pass code before being allowed to enter a program number to edit.

When you enter a number for a stored program and push the **Enter** key the program steps are displayed. Using the up and down arrow keys allow the user select the step in the existing program to edit. Move the cursor to that step and press the **Enter** key. The next screen to pop up will show the step's parameter and its value.

**NOTE: A list of Op-Codes appears in Chapter 6 of this manual.**

Example:

Parameter	Value
Opcode	SOAK
Time (hh:mm)	3:45

Highlighting the Opcode line and pressing the **Enter** button brings up a screen that shows all of the possible Opcodes. Use the Up or Down arrow keys to select the Opcode that you want to use for the program step that you are editing and press the **Enter** key. To change the Time option, highlight the line and press the **Enter** key. The next screen is the "Time Edit" screen. If you wish to change the hour, press the **Hour** button in the upper right-hand corner. If you want to change the minutes press the **Min** button. The next screen that pops up in both cases is a numeric keypad. Enter the number of hours or minutes that you wish to permanently change the recipe to and press the **Enter** button. If you DO NOT wish to make any changes press the **Esc** button.

Press the **Set** button to save the changes in the program. Notice that the time has been changed on the program segment that you were editing. If you wish to save this change, press the **Save** button. You will notice that a numeric keypad pops up and asks you to enter the number of the program that you wish to save. It defaults to the program number that you were editing. If this is the program that you wish to save the change, press the **Enter** key. If you wish to save this as a new program, press the **Clr** button on the numeric keypad, enter the number of the recipe that you want to save it as and press the **Enter** button. At this point, Program Editing is done and the display returns back to the Menu screen.

**NOTE: See Chapter 6 of this manual for some sample programs.**

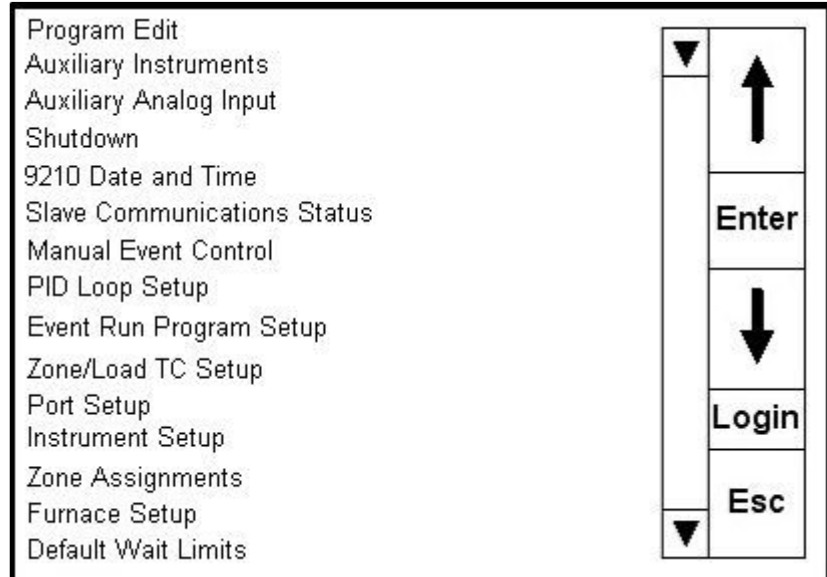

### Auxiliary Instruments

The Auxiliary Instruments screen shows the instruments slaved to the Series 9210 and their process variables. This screen is read-only.

### Auxiliary Analog Input

The Auxiliary Analog Input screen shows the information from all three of the 9210's inputs and any attached analog input modules such as load T/C's, flows from electronic flow meters, etc. This screen is read-only.

### Shutdown (Display)

The Shutdown selection pops up another screen asking whether or not the user wishes to shutdown the interface with the Series 9210. The two responses possible are either **Yes** or **No**.

**Yes** will shut down the 9210 interface program and display a common Windows desktop. You can now turn the power off to the operator interface without upsetting any of the settings. **No** returns the user to the initial status screen. Remember that shutting down the operator interface does not shut down the Series 9210 Controller.

### 9210 Date and Time

Highlighting the date and pressing **Enter** displays the Date Edit screen. The current date will be displayed at the top. The date is displayed in a box with scroll bars on the left in long version – Day of the week as well as month, day, and year (Friday January 4, 2008). Any portion of the date can be individually selected. To change any part of the date, select it and use the scroll bars to change the value. For example, to change the month, select the current month and press the up or down scroll bar to change the month to the specific month desired. When all of the changes have been made, press the **Set** button to save the changes, or press the **Cancel** button to cancel any changes.

Highlighting the time and pressing **Enter** displays the Time Edit screen. The current time will be displayed at the top. The new time can be entered through the use of the **Hour** and **Min** buttons. Pressing the **Hour** button will allow the user to change the hour, and pressing the **Min** button will allow the user to change the minutes. Pressing either of these buttons will display a numeric keypad that will allow the user to enter the new time. The new time will be displayed on the screen as well. When all of the changes have been made, press the **Set** button to save the changes, or press the **Cancel** button to cancel any changes.

### Slave Communications Status

The Slave Communications Status screen displays the auxiliary instruments and their status, if any. For a typical Nitriding application, the following slave instruments are used and should show a communications status ("Status") of **OK**:

- Instrument 7 – Nitrogen Flow Controller Board
- Instrument 8 – Ammonia Flow Controller Board
- Instrument 9 – Dissociate Ammonia Flow Controller Board
- Instrument 11 – Micrologix 1200 PLC

All other instruments will display N/A for communication status.

The possible communications messages that can be displayed are:

- N/A – No instrument is connected
- Bad – No communications exist
- ??? – Communications exist, but there are frequent errors
- ?OK – Communications exist, but there are occasional errors
- OK – Communication is established and working properly

This screen is read-only.

## Manual Event Control

The Manual Event Control screen will allow the user to manually control the events for the 9210 instrument.

Highlighting a specific event and pressing the **Enter** button will allow the user to turn the event **On** or **Off**. This will activate or deactivate whatever digital contact is connected to that particular event.

The following is a list of Events typically used with the Control system:

- Event 0 – Nitrogen Addition
- Event 1 – Ammonia Addition
- Event 2 – Dissociated Ammonia Addition
- Event 3 – Spare
- Event 4 – Spare
- Event 5 – Spare
- Event 6 – Spare
- Event 7 – Sample Cell Enable
- Event 8 – Spare
- Event 9 – Spare
- Event 10 – Spare
- Event 11 – Spare
- Event 12 – Spare
- Event 13 – Spare
- Event 14 – Spare
- Event 15 – Spare

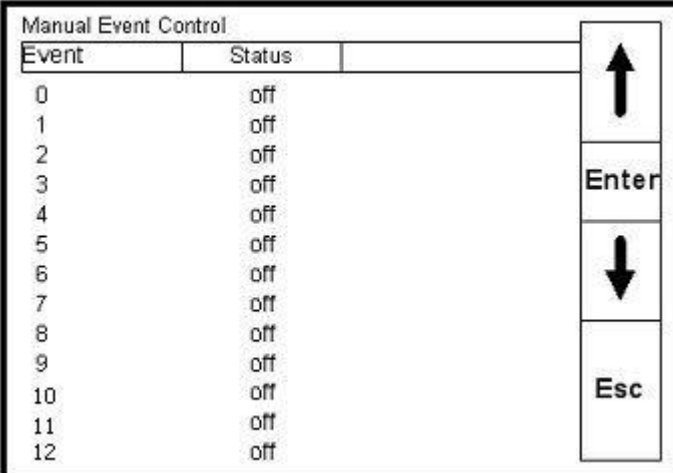

Event	Status
0	off
1	off
2	off
3	off
4	off
5	off
6	off
7	off
8	off
9	off
10	off
11	off
12	off

Navigation buttons on the right: Up arrow, Enter, Down arrow, Esc.

Pressing the **Esc** button returns you to the original Menu screen. Be sure to turn OFF all events turned on manually prior to starting a recipe cycle. This will ensure that the process will run as designed.

## PID Loop Setup

The PID Loop Setup screen displays Loop 1 and its control parameter - i.e. % Dissociation/Kn, Loop 2 and its parameter - Temperature, and Loop 3 and its parameter - Backpressure.

The top two blue arrows move you from one loop to the other. Below each of the loops is shown the PID parameters as they exist in the Series 9210 at that particular moment.

Using the lower up and down arrow keys allows the operator/supervisor to highlight the parameters shown in the lower portion of the screen. These parameters include proportional band, reset, rate, probe millivolts, process variable, setpoint, percent output, mode, integral preset, cycle time, setpoint change limit, control mode, low limit, high limit, and 0 setpoint stops control. Some of the parameters are read-only, such as probe millivolts, process variable, and Pct Out (percent control output). Pressing the **Enter** key when the parameter is highlighted can change all of the other parameters. This will display a numeric keypad or a menu of choices that will allow you to change the specific parameter. Highlight/enter your choice and press the **Enter** button to make the appropriate selection.

### **Change setpoint overshoot protection**

When the "Change Setpoint" is set to any value other than OFF, the PID control operates normally until there is a setpoint change. When a setpoint change occurs, the PID algorithm uses PB only (i.e. it ignores

the Reset (I) and Rate (D)) until the % output from the specified loop falls below the value specified. Then it will begin calculating reset and rate and return to normal operation.

Example: Change setpoint is set at 80%; Current setpoint is 1500

New setpoint is 1700 - % output rapidly goes to 100%, PID ignores Reset and Rate.

Temperature gets within PB, % Output starts to drop.

When % Output drops below 80%, PID operation returns to normal with Reset and Rate applied.

Normally overshoot is caused by a buildup of the Reset error term. By ignoring this term until the temperature is with PB, the Reset term is minimized, thus reducing the overshoot error. You should be cautious not to set the Change Setpoint value too low - e.g. if the furnace controls 1700 in a steady state at 50% output and you set the Change Setpoint value to 40% and the PB value is low, you could find yourself in a situation where you never see 40% output and remain in a **PB only** control mode.

Default PID Parameters for Loop 1 - %Dissociation/Kn, Loop 2 – Temperature, and Loop 3 - Backpressure

Loop 1 Default PID Parameters	Loop 2 Default PID Parameters	Loop 3 Default PID Parameters
Proportional Band: 1.3	Proportional Band: 20.0	Proportional Band: 4.0
Reset: 0.01	Reset: 0.10	Reset: 0.10
Rate: 0.00	Rate: 0.0	Rate: 0.0
Mode: Auto	Mode: Auto	Mode: Auto
Integral Preset: 0	Integral Preset: 0	Integral Preset: 0
Cycle time: 24	Cycle time: 60	Cycle time: 60
Setpoint Change Limit: OFF	Setpoint Chazge Limit: 80%	Setpoint Change Limit: OFF
Control Mode: Dual Direct	Control Mode: Single Reverse	Control Mode: Single Reverse
Low Limit: -100	Low Limit: 0	Low Limit: 0
Hight Limit: 100	Hight Limit: 100	Hight Limit: 100
0 set point stops control: no	0 set point stops control: no	0 set point stops control: no

The **Esc** key on some of the screens returns you to the previous screen without any changes taking affect. From the PID Setup screen, the **Esc** key takes you back to the Menu screen.

### Event Run Program Setup

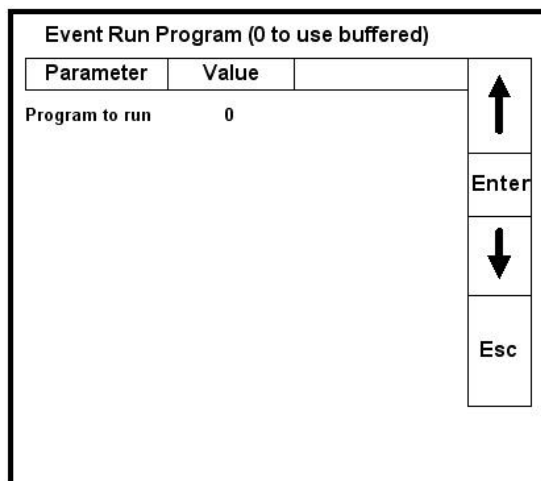

This screen is used to start a program stored in the 9210 by contact closure between terminals 21 (Digital In Com) and 17 (Digital In 1). The value entered at program to run will start with contact closure.

Pressing **Enter** pops up the Current Value Screen, showing the current value in the Series 9210. To make an adjustment, enter the program number, using the numeric keypad and press the **Enter** key. This returns you to the original Event Run Program Screen that now shows the new program number that you have entered. If you do not wish to make the change simply press the **Esc** key which takes you back to the Event Run Program Screen with NO change being made to the Event Run Program.

### Zone / Load TC Setup

This screen is used for Nitrider applications that utilize a Load Thermocouple in addition to the Furnace Control Thermocouple for Soak statements. The operator must manually select the Thermocouples for the

9210 to use in determining when to start/hold/stop Soak timers in a recipe. For Nitrider applications that do not use a Load Thermocouple, this menu can be ignored.

Use the up and down arrow keys to highlight a specific thermocouple. The Load TC Enable can be either: **Off**, **On**, or **On + Alarm**. Pressing the **Enter** button while the item is highlighted changes the current status of that particular selection to either **Active** or **Inactive (blank)**.

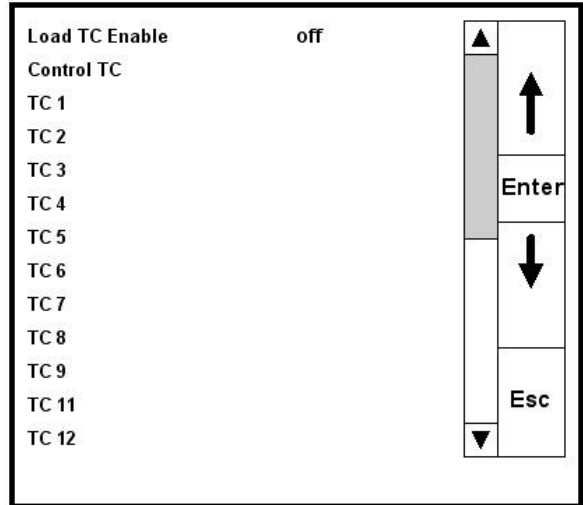

### Port Setup

Highlighting this menu selection and pressing the **Enter** button moves you to the Port Setup screen.

**Warning: Changes to this screen should not be made without consulting SSi at 513-772-0060.**

Parameter	Value
Host 232 Baud	TPC-642S/SE
Host 232 Mode	Modbus
Host 485 (3,4) Baud	19200
Host 485 (3,4) Mode	Modbus
Host 485 (3,4) Address	1
Slave 1 (5,6) Baud	19200
Slave 1 (5,6) Mode	Modbus
Slave 2 (22,23) Baud	19200
Slave 2 (22,23) Mode	Modbus
232/H2 Port Baud	9600
PLC Type	Micrologix Modbus

These values can be changed by using the up and down arrow keys to highlight the selection. Press the **Enter** button to select the item. A selection of communication protocols is displayed. Make the desired selection and press the **Enter** button. The **Cancel** button takes you back to the previous screen without changes being made.

### Instrument Setup

**WARNING: The 9210 Instrument Setup is pre-configured and tested prior to shipment. This screen should not be changed without consulting SSi at 513-772-0060.**

The Instrument Setup screen will allow the user to set up the slave instruments. The first level allows you to select the instrument to setup. To highlight the desired instrument use the first set of blue up and down arrow keys and then press the **Enter** button. This will display a list of controllers: **Atmosphere Controllers**, then **Temperature Controllers**, and then **Miscellaneous Controllers**. The Port, Address, and Atmosphere, Temperature, Events, and Quench Assignments can also be modified from the lower portion of the screen. Pressing the **Esc** button will return you to the Menu screen.

Zone Assignments

**WARNING: This screen should not be changed without consulting SSi at 513-772-0060.**

The zone assignment feature allows the SERIES 9210 program to change set points on all instruments of a multi-zone furnace. The SERIES 9210 has up to five (5) temperature and atmosphere zone assignments available. The SERIES 9210 programmer looks for appropriate zone assignments whenever a set point is to be sent to the atmosphere or temperature controller. The temperature set point is sent to every instrument number in the temperature zone assignment.

If the *ZONE\_OFF* (Zone Offset) opcode had been used in the program, the set point sent to the specified zone instrument would have the offset added. For example, a 3-zone pit furnace where the bottom zone usually has a higher set point. The middle zone and the top zone usually have a lower set point. The bottom zone temperature controller is assigned to zone 1, the middle temperature controllers to zone 2, and the top zone controller to zone 3.

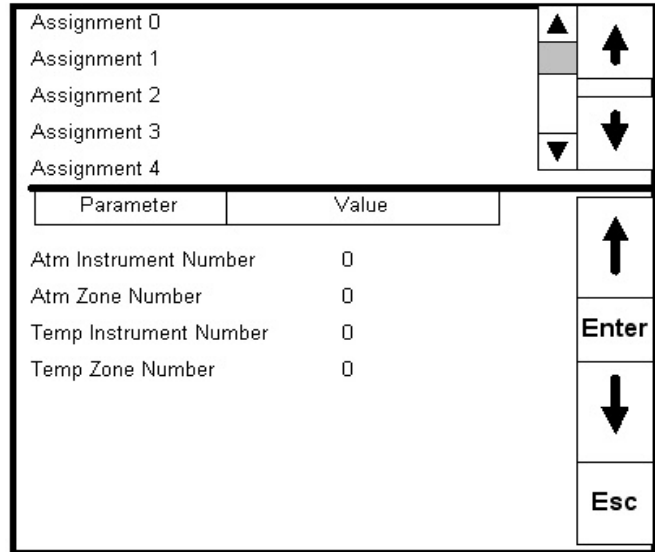

If the first three steps of a program are as shown below, then the bottom zone set point is 1725, the middle zones are 1750, and the top zone is 1800.

Step	opcode	Temperature	Atmosphere	Option
1	<i>ZONE_OFF</i>	50		1
2	<i>ZONE_OFF</i>	25		3
3	<i>SETPT</i>	1750		

The first step sets the offset for zone 1 to -25 degrees; therefore, the bottom zone controller would be sent a set point of 1725 when step 3 is executed. Likewise step 2 sets the offset for zone 4 to 50 degrees. The top zone then receives a set point of 1800. The middle zone controller would receive the 1750. The temperature controller displayed on the Status Display is instrument #2. If instrument #2 were the top zone controller then the Status Display would show the 1800-degree set point.

When using the multi-zone offset feature, the atmosphere and temperature controller assigned as instruments 1 and 2 should be in zones that will not be offset.

## Furnace Setup

Furnace Setup		▲	▲
Parameter	Value		▲
Nitrider Mode	H2 and Dissociation monitor		▲
H2 Cell Type	Hi		Enter
H2 RS-232 Comms	No		▼
Temp display	Internal		Esc
LP3 control	None		
N2 Valve	No		
NH3 Valve	No		
D.A. Valve	No		
Aux Valve	No		
Temperature Mode	°F		
Programmer			
Atm. Inst	Loop 1	▼	

The “Nitrider Mode” selection will allow the user to select the specific Nitriding mode:

**H2 and Dissociation**

**NH3 and Dissociation**

**H2, NH3 and Dissociation**

**H2, NH3 and Nit. Potential**

**H2 and Nit. Potential**

**NH3 and Nit. Potential**

**H2 and H2 Control**

**NH3 and NH3 Control**

The “H2 Cell Type” selection will allow the user to set the H2 cell type. It can be either **Hi** or **H2**.

The “H2 RS-232 Comms” selection will allow the user to know if there are RS-232 communications. It can be either **Yes** or **No**.

The “Temp display” selection will allow the user to set the temperature display source. It can be either **Internal** or **SPP Instrument**.

The “LP3 Control” selection allows the user to set the loop 3 control factor:

**None**

**BP (Back Pressure)**

**N/A**

**Temp**

The “N2 Valve” selection will allow the user to set the N2 valve. It can be either **Yes** or **No**.

The “NH3 Valve” selection will allow the user to set the NH3 valve. It can be either **Yes** or **No**.

The “D.A. Valve” selection will allow the user to set the Dissociated Ammonia valve. It can be either **Yes** or **No**.

The “Aux Valve” selection will allow the user to set the auxiliary valve. It can be either **Yes** or **No**.

The “Temperature Mode” selection will allow the user to set the temperature mode. It can be either **°F** (Fahrenheit) or **°C** (Celsius).

The programmer section will allow the user to set up the different instruments for the programmer.

The “Atm. Inst” selection will allow the user to set the atmosphere instrument:

**Internal Loop 1**

**Internal Loop 2**

**Internal Loop 3**

**Instrument 1 – Instrument 25**

The “Temp. Inst” selection will allow the user to set the temperature instrument:

**Internal Loop 1**

**Internal Loop 2**

**Internal Loop 3**

**Instrument 1 – Instrument 25**

The “Event Inst” selection will allow the user to set the events instrument:

**Internal**

**Instrument 1 – Instrument 25**

The “Quench Inst” selection will allow the user to set the quench instrument:

**Internal Loop 1**

**Internal Loop 2**

**Internal Loop 3**

**Instrument 1 – Instrument 25**

The “End of Quench Event” will allow the user to set the end of quench event. It can be **event 0** through **event 14**.

The “Quench Speed Event” will allow the user to set the quench speed event. It can be **event 0** through **event 14**.

The “Quench Run Event” will allow the user to set the quench run event. It can be **event 0** through **event 14**.

The “Nitrider Bias” selection can be used to adjust the % Dissociation/Kn reading to match Pipette or Metallurgical readings. Setting this value to **5.0** will increase the reading from 20 to 25, whereas setting the value to **-5.0** will decrease the reading from 20 to 15. This can range from **-10.0** to **10.0**

The “SSI Flow Signal” selection will allow the user to set the flow signal. It can be either **Analog** or **Digital/485**.

The “End Recipe Events Clear” selection will allow the user to clear out the events at the end of a recipe. It can be either **Yes** or **No**.

#### Default Wait Limits

Parameter	Value
Temperature Wait Limit	15 °
Atmosphere Wait Limit	10

The wait limits are used in the recipe programming. A wait limit allows the program to move to the next step once the process variable (or the actual furnace) has gotten to within the default wait limits that are indicated on this screen.

Highlighting your choice to be changed and pressing the **Enter** key moves you to a numeric keypad that allows you to enter a new value by touching the appropriate keys. The Temperature Wait Limit can range from **0** to **50** degrees. The Atmosphere Wait Limit can range from **0.00** to **0.49**. Pressing the **Esc** key takes you back to the Menu screen.

#### Furnace Name

Parameter	Value
Furnace Name	Nitrider
PV1 Name	Dissociation
PV2 Name	Temperature
PV3 Name	Back Pressure

Select the parameter to edit and press the **Enter** key to display an alphanumeric keyboard. Enter the name that you wish to be displayed.



Alarm Setup

The Alarm Setup menu is a two-level screen. The first level allows you to select the alarm – **Alarm1 – Alarm 3**. The Second level scrolls through the alarm parameters.

Parameter	Value
Setpoint	2500
Alarm Type	PV2 proc high
Hysteresis	1

Using the lower blue up and down arrow keys, select the parameter to modify, and then press the **Enter** button. The “Setpoint” selection will allow the user to enter the setpoint for the alarm. This will display a numeric keypad. This can range from **-9999** to **9999**. The “Alarm Type” selection will allow the user to set the type of alarm. This will display a two-level screen. The top level has the following options:

- Process High**
- Process Low**
- Band, Normally Open**
- Band, Normally Closed**
- Deviation, Normally Open**
- Deviation, Normally Closed**

The bottom level has the following options:

- PV 1 Value**
- PV 2 Value**
- PV 3 Value**
- Input 1 Value**
- Input 2 Value**
- Input 3 Value**
- PO1 Value**
- PO2 Value**
- PO3 Value**

The “Hysteresis” selection will allow the user to set the hysteresis. This will display a numeric keypad. This can range from **0** to **9999**.

If you are configuring more than one alarm, follow the above instructions for each alarm that you are configuring.

**Standard Setup for DA Alarm with Delays**

DA is usually set up as PV 1 (Loop 1)  
8.00 = 8% D.A.

Parameter	Value
Setpoint	8.00
Alarm Type	PV1 Band NO (Out of Band)
Hysteresis	1
Smart Alarm	Disabled
ON Delay Time (sec)	3600

## Relay Assignment

This menu selection allows the user to assign the action to the selected Relay Output.

All eight of the 9210's relay outputs are assigned in this screen. To select a Relay Output to modify, use the up or down arrow keys to highlight the event.

Highlighting the "Assignment" selection that you wish to assign and pressing the **Enter** button takes you to a screen that has the following choices

- Loop 1 fwd
- Loop 1 rev
- Loop 2 fwd
- Loop 2 rev
- Loop 3 fwd
- Loop 3 rev
- Programmer alarm
- Alarm 1
- Alarm 2
- Alarm 3
- Event 0 through Event 15
- Burn off
- IN 1 Relay SP A
- IN 1 Relay SP B
- IN 1 Relay SP C
- IN 2 Relay SP A
- IN 2 Relay SP B
- IN 2 Relay SP C
- IN 3 Relay SP A
- IN 3 Relay SP B
- IN 3 Relay SP C
- Alarm Combination (can be any combination below)
  - Programmer Alarm
  - Alarm 1
  - Alarm 2
  - Alarm 3

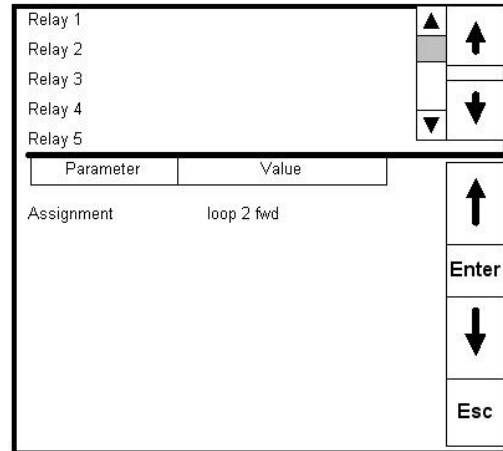

## Relay Set Points

Relay On/Off Setpoints	
Parameter	Value
Relay ON SP for IN1 A	0
Relay OFF SP for IN1 A	0
Relay ON SP for IN1 B	0
Relay OFF SP for IN1 B	0
Relay ON SP for IN1 C	0
Relay OFF SP for IN1 C	0
Relay ON SP for IN2 A	0
Relay OFF SP for IN2 A	0
Relay ON SP for IN2 B	0
Relay OFF SP for IN2 B	0
Relay ON SP for IN2 C	0
Relay OFF SP for IN2 C	0
Relay ON SP for IN3 A	0

This menu screen is not used and should be ignored. Contact Super Systems Inc at 513-772-0060 before making any changes to this screen. This screen will allow the user to set the ON/OFF setpoints for Input 1, 2, and 3 A, B, and C relays. Selecting a setpoint to modify and pressing the **Enter** button will display a numeric keypad. This can range from **-9999** to **9999**.

## Analog Input Setup

This menu option displays a two-level screen with the top level showing the three inputs. Use the blue up and down arrow keys to select one of the inputs. Pressing the "Enter" key takes you to a menu of parameters that can be assigned to any of the three inputs. Included are thermocouples, voltage, and current inputs. The lower zone of the "Analog Input Setup" screen contains a table:

Parameter	Value
TC Type	S
Filter Time	0
Initial Scale	0
Full Scale	3000
Decimal Point Location	0
Open TC	Up scale
Input offset	0
Use curve	0

Select the "TC Type" option and press the **Enter** button. This will display a screen with the different input types available. *Note: See the Input type selections for the Series 9210 below for the different input types available.* The "Filter Time" selection will display a numeric keypad from which the user can enter the new filter time. This can range from **0** to **9999**. The "Initial Scale" selection will display a numeric keypad from which the user can enter the new initial scale. This can range from **-9999** to **9999**. The "Full Scale" selection will display a numeric keypad from which the user can enter the new full scale. This can range from **-999-** to **9999**. The "Decimal Point Location" selection will display a numeric keypad from which the user can enter the new decimal point location. This can range from **0** to **4**. The "Open TC" selection will display a screen from which the user can enter the new filter time. This can be either **Up Scale** or **Down Scale**. The "Input Offset" selection will display a numeric keypad from which the user can enter the new input offset. This can range from **-10** to **10**. The "Use Curve" selection will display a numeric keypad from which the user can enter the new curve to use. This can range from **0** to **5**. **0** means no curve is used. Continue until all values associated/required by the input type have been entered. Pressing the **Esc** key takes you back to the configuration menu.

Input type selections for the Series 9210:

Input Type Options	T/C's B, C, E, J, K, N, NNM, R, S, T
	2.5 Volts
	1.25 Volts
	78.125 Millivolts
	19.53125 Millivolts
	4 - 20 mA (124 Ohm precision shunt required)
	25 Volts (Requires internal jumper)
	12.5 Volts (Requires internal jumper)
	781.25 Millivolts (Requires internal jumper)
	195.3125 Millivolts (Requires internal jumper)

### Analog Output Setup

This menu screen is similar in function to the *Analog Input Setup* screen, with the exception that these are analog outputs, not inputs. There are two analog output available. The top blue up and down arrow keys highlight either Output 1 or Output 2. The lower blue up and down arrow keys will allow the user to set up the analog output settings.

Parameter	Value
-----------	-------

Assignment	PV 2 retrans
Offset	0
Range	100

The “Assignment” selection will display a screen from which the user can select the new assignment. For example you can re-transmit PV1 (Process Variable 1 - %C) to a chart recorder or an analog input board in a PLC. In most Nitriding applications Output 1 is used to control the backpressure and Output 2 is used for Temperature control. The list of options is:

**PV 1 retrans**

Loop 1 Inc

Loop 1 Dec

Loop 1 Combo

**PV 2 retrans**

Loop 2 Inc

Loop 2 Dec

Loop 2 Combo

**PV 3 retrans**

Loop 3 Inc

Loop 3 Dec

Loop 3 Combo

**Input 1 retrans**

Input 2 retrans

Input 3 retrans

Input 4 retrans

The “Offset” selection will allow the user to set the offset. This will display a numeric keypad. This will range from **-9999** to **9999**.

The “Range” selection will allow the user to set the range of the output. This will display a numeric keypad. This will range from **-9999** to **9999**.

Pressing the **Esc** key returns you to the configuration menu.

Passcode and Alarm

Parameter	Value
Level 1 Code	1
Level 2 Code	2
Web Level 1 Code	111
Web Level 2 Code	222
Web Change Enable	1
No Alarm	Contact is Open
Alarm Text Setup	
Alarm 0 – Alarm 99	User Alarm xx

The values shown in the above table are the default values. The parameter “No Alarm” means that if there is NO CONTROLLER ALARM, the controller alarm relay is NO. The “Level 1 Code” and the “Level 2 Code” selections will allow the user to set the Supervisor and Administration passcodes, respectively. Either of these options will display a numeric keypad that will range from **0** to **9999**. The “Web Level 1 Code” and the “Web Level 2 Code” selections will allow the user to set the Supervisor and Administration passcodes, respectively, for the 9210’s web page. Either of these options will display a numeric keypad that will range from **0** to **9999**. The “Web Change Enable” selection will allow the user determine if changes can be made to the instrument through the web page. This will display a numeric keypad that can be either **1** (Change OK) or **0** (No Change Allowed). The “No Alarm” selection will allow the user to set what the no alarm state is. This will display a numeric keypad that can be either **0** (Contact is Open) or **1** (Contact is Closed). This allows the operator to assign the controller alarm as a NC contact such as a 1400°F alarm. The “Alarm

Text Setup” section will allow the user to set the alarm text for up to ninety-nine user alarms. Any of these options will display an alphanumeric keypad. Press the **Esc** key to return to the configuration menu.

IP Address

Parameter	Value
IP Address 1	192
IP Address 2	168
IP Address 3	0
IP Address 4	200
IP Address Mask 1	255
IP Address Mask 2	255
IP Address Mask 3	255
IP Address Mask 4	0
IP Address Gateway 1	192
IP Address Gateway 2	168
IP Address Gateway 3	1
IP Address Gateway 4	1

Highlighting the parameter that needs to be entered and pressing the **Enter** button displays a numeric keypad that can be used to enter the required value. This will range from **0** to **256**.

The default IP address is: 192.168.0.200

The default IP Address Gateway is: 192.168.1.1

Pressing the **Esc** key returns you to the configuration menu.

Event Control

Hold Instrument Number	0	▲	▲
Hold Minimum PV	0		
Hold Maximum PV	2000		
Event for Program Run	-1	Enter	▼
Event for Program Reset	-1		
Event 0		Esc	▼
Event 1			
Event 2			
Event 3			
Event 4			
Event 5			
Event 6			
Event 7			
Event 8			
Event 9			

This menu option will allow the user to set up the event control for the 9210. The “Hold Instrument Number” selection will display a numeric keypad that can range from **0** to **11**. The “Hold Minimum PV” selection will display a numeric keypad that will range from **0** to **4000**. The “Hold Maximum PV” selection will display a numeric keypad that will range from **0** to **4000**. The “Event for Program Run” selection will display a numeric keypad that will range from **-1** to **15**. A value of **-1** means there is no event. The “Event for Program Reset” selection will display a numeric keypad that will range from **-1** to **15**. A value of **-1** means there is no event. The “Event 0” through “Event 15” selection will allow the user to assign the specific events. The list of options for this selection is:

- **Event Inactive**
- **Event Active, Open Triggers Hold**
- **Event Active, Closed Triggers Hold**

## Valve Configuration

This screen provides setup information for the 9210 on the flow controller boards.

The “Decimal Place” selection determines how the 9210 will display gas flows. This will display a numeric keypad that can range from **0** to **4**.

The “Valve Control Mode” selection determines how the 9210 will adjust gas flows if required for %Dissociation. This will display a screen that will allow the user to select the mode. The choices are:

- Individual Trim
- Flow
- Ratio
- Auto

The “D.A. Switch Point” selection determines the control switch point for switching the atmosphere display from %Dissociation to Kn. This will display a numeric keypad that can range from **0** to **100**. The “Auto Valve Event” selection will allow the user to either turn the valve event on or off with a running program using the *Set Valve* opcode. This can be either **On** or **Off**.



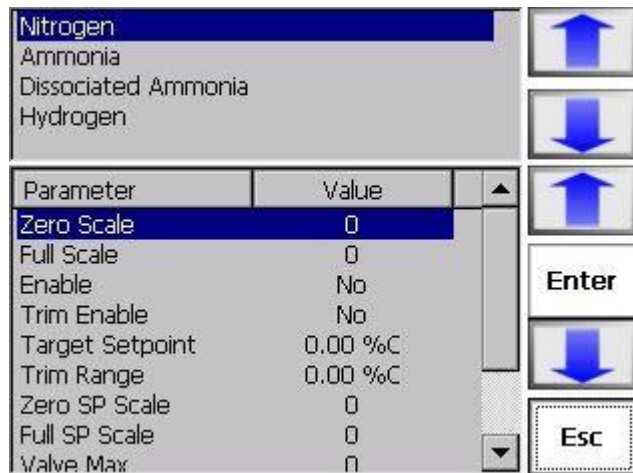

## Valve Setup



This screen is used to setup the 9210 based on how the flow meter boards are setup. This allows the 9210 to know how display each individual gas flow. There are four gases to select: **Nitrogen**, **Ammonia**, **Dissociated Ammonia**, and **Hydrogen**. Once a gas flow has been selected, the values for that flow will be displayed in the lower level. The “Zero Scale” selection will allow the user to set the zero scale for the flow. This will display a numeric keypad that can range from **0** to **30,000**. The “Full Scale” selection will allow the user to set the full scale for the flow. This will display a numeric keypad that can range from **0** to **30,000**. Selecting the “Enable” selection will allow the user to enable the flow. This will cycle between **Yes** and **No**. Selecting the “Trim Enable” selection will allow the user to

enable the trim flow. This will cycle between **Yes** and **No**. The “Target Setpoint” selection will allow the user to set the target setpoint for the flow. This will display a numeric keypad that can range from **0** to **2000**. The “Trim Range” selection will allow the user to set the trim range for the flow. This will display a

numeric keypad that can range from **0** to **2000**. The “Zero SP Scale” selection will allow the user to set the zero scale for the setpoint for the flow. This will display a numeric keypad that can range from **0** to **30,000**. The “Full SP Scale” selection will allow the user to set the full scale for the setpoint for the flow. This will display a numeric keypad that can range from **0** to **30,000**. The “Valve Max” selection will allow the user to set the valve maximum for the flow. This will display a numeric keypad that can range from **0** to **30,000**. The “Flow deviation setpoint” selection will allow the user to set the setpoint for the flow deviation alarm. This will display a numeric keypad that will range from **0** to **30,000**. A setpoint of 0 will disable the deviation alarm for the valve. The “Dev. Alarm delay (sec)” selection will allow the user to set the number of seconds before the deviation alarm will sound. This will

Parameter	Value	
Decimal Place	1	   
Valve Control Mode	Individual Trim	
D.A. Switch Point	2	
Auto Valve Event	off	

display a numeric keypad that will range from 0 to 30,000. *Note: The deviation alarm delay is entered in 1/10 minutes (6 seconds), so a 2 entered will be displayed as 12 seconds.*

### Standard Setup for Flow Alarms with Delays

The "Deviation Setpoint" is the flow alarm setpoint, and the "Dev. Alarm Delay (sec)" is the flow alarm delay time

	Valve 1	Valve 2	Valve 3	Valve 4
Zero Scale	0	0	0	0
Full Scale	300	300	150	0
Trim Enable	No	Yes	No	no
Target Setpoint	150	150	10	0
Trim Range	0	50	25	0
Zero SP Scale	0	0	0	0
Full SP Scale	300	300	150	0
Valve Max	300	300	150	0
Deviation Setpoint	20	60	10	Off
Dev. Alarm Delay (sec)	300	60	300	0
Gas Type	Nitrogen	Ammonia	Dissociated Ammonia	Hydrogen
Valve Decimal Place	0	0	0	0

### User Calibration

**\*\*\* Calibrate the inputs first, then perform a cold junction calibration \*\*\***

The user will need a thermocouple calibrator capable of outputting a thermocouple signal to calibrate the zero, span or cold junction value of the 9210 instrument. The user will need to connect the calibrator to one of the inputs on the instrument that will be calibrated. It is recommended to let everything (calibrator and instrument) sit for approximately thirty minutes to allow the temperature to achieve equilibrium. Set up the calibrator for the specific thermocouple type of the thermocouples in the 9210 instrument, i.e. type K, type J, etc. Then, source a specific temperature, like 1000 °F, or millivolt to the connected input. It is recommended that the actual temperature used be similar to an appropriate process temperature. For example, if your equipment normally operates at 1700 °F, then perform the cold junction calibration using a 1700 °F signal. It is important to note that when performing a zero or span calibration, *do not use* regular thermocouple wiring. Instead, use any kind of regular sensor wire, or even regular copper wire. To perform the calibrations, the user will need a calibrator that is capable of outputting volts, millivolts, and temperature.

*Note: The buttons on the screen always have the same functionality. The ←Back button will display the previous screen, if any. The Skip button will skip the current screen and display the next screen, if any. The*

*Next → button will display the next screen, if any. The Done button will close out the User Calibration menu. The Edit button will display a numeric keypad from which the user can enter a new value for the calibration process. The Calibrate button will begin the calibration process for the selected screen.*

The first screen in the *User Calibration* menu is the Calibrate Cold Junction screen. This will allow the user to enter an offset for the cold junction value. The current value is displayed directly above the progress bar and bottom row of buttons as "Current CJ value: XX.X ° F". Press the Calibrate button to set the cold junction offset. The progress bar at the bottom of the screen will display the calibration progress. **NOTE:**

***This function should be performed AFTER the inputs have been calibrated.***

The next screen is the Zero Input 1 Range 2 screen. This screen will allow the user to set the zero scale for Input 1 Range 2. A value of 0 millivolts will need to be sourced to the inputs. For a zero calibration, enter a 0 as the value of the terminal to correctly calibrate the inputs. The current Input 1 value will be displayed near the bottom of the screen as "Current Input 1 value: xxxx.xx uV". The progress bar at the bottom of the screen will display the calibration progress.

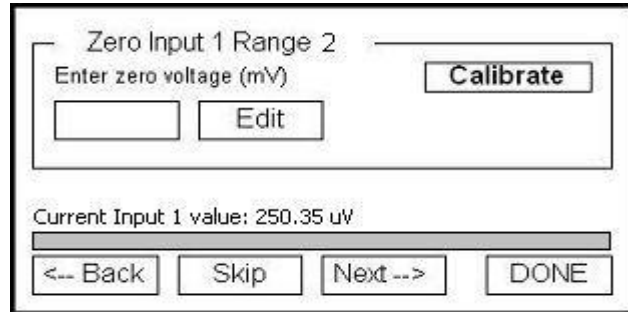

The next screen is the Span Input 1 Range 2 screen. This screen will allow the user to set the span value for Input 1 Range 2. A suggested value will be displayed next to the **Calibrate** button ("sugg. 65.000 mV"). The current Input 1 value will be displayed near the bottom of the screen as "Current Input 1 value: xxxx.xx uV". The progress bar at the bottom of the screen will display the calibration progress.

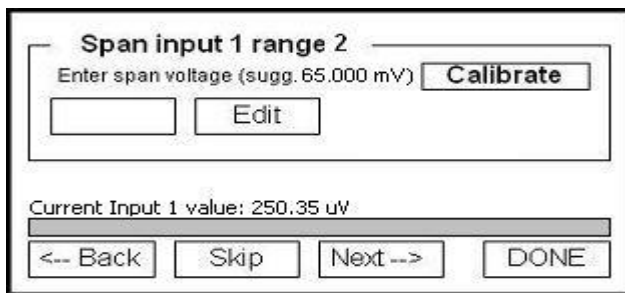

The next screen is the Zero Input 2 Range 0 screen. This screen will allow the user to set the zero scale for Input 2 Range 0. A value of 0 millivolts will need to be sourced to the inputs. For a zero calibration, enter a 0 as the value of the terminal to correctly calibrate the inputs. The current Input 2 value will be displayed near the bottom of the screen as "Current Input 2 value: xxxx.xx uV". The progress bar at the bottom of the screen will display the calibration progress.

This process can be repeated for the rest of the inputs.

**\*\*\* Once the inputs have been calibrated, go back to the first screen and perform a cold junction calibration \*\*\***

The next screen is the Zero Output 1 screen. This screen will allow the user to set the zero value for Output 1. Measured at terminals 24(-) and 25(+) for this step. The progress bar at the bottom of the screen will display the calibration progress.

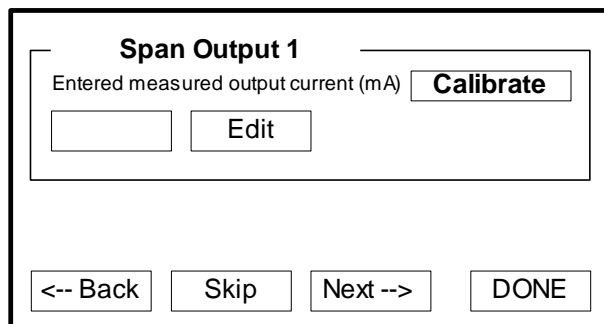
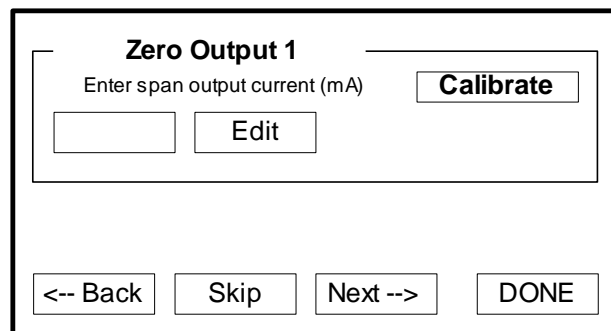

The next screen is the Span Output 1 screen. This screen will allow the user to set the span value for Output 1. Measured at terminals 24(-) and 25(+) for this step. The progress bar at the bottom of the screen will display the calibration progress. This process can be repeated for the rest of the outputs.

The next screen indicates that the calibration process is complete.



### Full Calibration

This screen is used by SSI personnel, and it is a longer version of the *User Calibration* menu.

### Set Menu Security

This menu allows the user to set the security level for all of the menu screens to one of three levels:

1. Operator – Lowest Level, No Pass code Required
2. Supervisor – Middle Level, Level 1 Pass code Required
3. Administrator – Highest Level, Level 2 Pass code Required.

The menu items with security levels are:

<u>Menu Item</u>	<u>Security Level</u>
Program Edit	Supervisor
Auxiliary Instruments	Operator
Auxiliary Analog Input	Operator
Shutdown	Operator
9210 Date and Time	Supervisor
Slave Communications Status	Supervisor
Manual Event Control	Supervisor
PID Loop Setup	Administrator
Event Run Program Setup	Administrator
Zone/Load TC Setup	Administrator
Port Setup	Administrator
Instrument Setup	Administrator
Zone Assignments	Administrator
Furnace Setup	Administrator
Default Wait Limits	Administrator
Furnace Name	Administrator
Alarm Setup	Administrator
Relay Assignments	Administrator
Relay Setpoints	Administrator
Analog Input Setup	Administrator
Analog Output Setup	Administrator
Passcode and Alarm	Administrator
IP Address	Administrator
Event Control	Administrator
Valve Configuration	Administrator
Valve Setup	Administrator
User Calibration	Administrator
Full Calibration	Administrator
Set Menu Security	Administrator
Read/Write Raw Data	Administrator
Curve Entry	Administrator
Alternate PID Setup	Administrator
Analog Input Board Setup	Administrator
AI Board Calibration	Administrator
Program Run	Administrator
PLC Calibration	Administrator
ADAM Correction	Administrator
Aux SP Configuration	Administrator

### Read/Write Raw Data

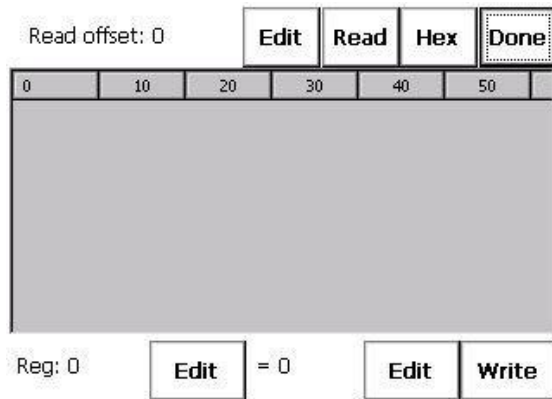

This menu is used to view raw data as stored in the 9210. This is only for use by qualified personnel under direction of SSI. Contact Super Systems Inc at 513-772-0060 before modifying any of these values. The "Read Offset:" at the top of the screen will indicate where in the 9210's registers the application will begin reading. Press the **Edit** button to edit the read offset. Press the **Read** button to read the values from the 9210. The application will read 60 registers at a time. Press the **Hex** button to convert the values to their hexadecimal counterparts. The **Hex** button will now read **Dec**. Pressing the **Dec** button will convert the values to their decimal counterparts. The **Dec** button will now read **Hex**. Pressing the **Done** button will close out

the menu option. The "Reg:" at the bottom of the screen will indicate where in the 9210's registers the application will begin writing. Press the left **Edit** button to edit the write offset. Press the right **Edit** button (next to the **Write** button) to edit the value to write to the register. Press the **Write** button to write the value. *Note: This screen does not continuously update, so the **Read** button will have to be pressed to ensure that any changes were made.*

### Curve Entry

This menu is not used with the Nitrider Control system and should be ignored.

### Alternate PID Setup

This menu is used to allow for up to sixteen different PID Loops that can be used by the control system. These PID loops can be used in place of the PID parameters for Loop 1, 2 or 3. To use an alternate PID for a control Loop, it must be done via the 9210 Recipe. Contact SSI at 513-772-0060 for assistance with this feature. Use the top blue up and down arrows to select the separate PID loops. Use the bottom up and down arrows to select the parameters for the selected loop. All of the parameters will display a numeric keypad. The "Proportional Band" can range from **0** to **999**. The "Reset" can range from **0.00** to **10.00**. The "Rate" can range from **0.00** to **10.00**. The "Integral Preset" can range from **-100** to **100**. The "High Limit" can range from **-100** to **100**. The "Low Limit" can range from **-100** to **100**.

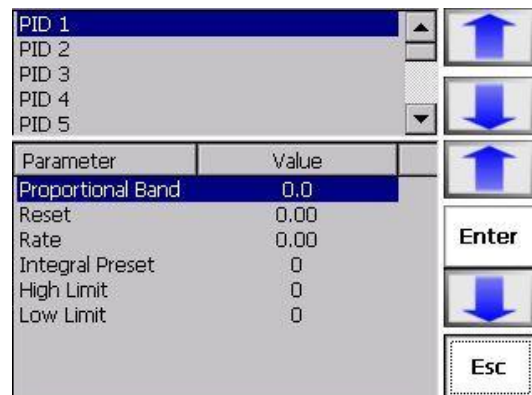

### Analog Input Board Setup

This menu is not used with the Nitrider Control system and should be ignored.

### PLC Calibration

This menu is only used with the Nitrider Control system when the PLC is handling the gas flow readings and control. Contact SSI at 513-772-0060 for assistance with this feature. Press the appropriate button to select that gas valve – i.e., press **H2** for the H2 valve. The selected valve will be displayed at the top of the screen.

N2 Valve Selected		N2
<b>Setpoint Output</b> Select Zero or Span for Setpoint Output <input type="button" value="Zero"/> <input type="button" value="Span"/> <input type="button" value="Cancel"/> <input type="button" value="Nominal"/> <input type="text"/> <input type="button" value="Edit"/> <input type="button" value="Calibrate"/>		NH3
		D.A.
<b>Flow Input</b> Select Zero or Span for Flow Input <input type="button" value="Zero"/> <input type="button" value="Span"/> <input type="button" value="Cancel"/> <input type="button" value="Nominal"/> <input type="text"/> <input type="button" value="Edit"/> <input type="button" value="Calibrate"/>		H2
		Done

The first section is for the Setpoint Output. All of the buttons in both sections function identically. Press the **Zero** button to set the zero value. The text above the buttons will read "Enter measured Zero value (mA) and press calibrate". Press the **Span** button to set the span value. The text above the buttons will read "Enter measured Span value (mA) and press calibrate". Press the **Cancel** button to cancel the zero or span process. Press the **Nominal** button to set nominal values for the Setpoint Output. This will display a message box: "Set nominal zero values. Are you sure?" Press the **Yes** button to set the nominal values, or press the **No** button to cancel the nominal value set. Press the **Edit** button to display a numeric keypad that will allow the user to edit the zero or span value. This can range from **0.00** to **32767.00**. Press the **Calibrate** button to begin the

calibration process. This will display a message: "Begin Calibration. Are you sure?" Press the **Yes** button to begin the calibration process, or press the **No** button to cancel the calibration process.

The second section is for the Flow Input. Press the **Zero** button to set the zero value. The text above the buttons will read "Enter observed Zero flow value and press calibrate". Press the **Span** button to set the span value. The text above the buttons will read "Enter observed Span flow value and press calibrate". Press the **Cancel** button to cancel the zero or span process. Press the **Nominal** button to set nominal values for the Setpoint Output. This will display a message box: "Set nominal zero values. Are you sure?" Press the **Yes** button to set the nominal values, or press the **No** button to cancel the nominal value set. Press the **Edit** button to display a numeric keypad that will allow the user to edit the zero or span value. This can range from **0.00** to **32767.00**. Press the **Calibrate** button to begin the calibration process. This will display a message: "Begin Calibration. Are you sure?" Press the **Yes** button to begin the calibration process, or press the **No** button to cancel the calibration process. Press the **Done** button to return to the *Configuration* menu.

### Adam Correction

This menu is only used with the Nitrider Control system that utilizes an ADAM module for Load Thermocouples. Contact SSI at 513-772-0060 for assistance with this feature. The ADAM module offset correction menu option gives the user the ability to offset any input on any ADAM module. The offset can be in degrees + or -, and it is typically used to compensate for incorrect T/C wires. The offsets are entered and displayed on the screen without decimal points. For example, an offset of **255** would actually be an offset of **25.5** degrees +, and an offset of **-85** would be an offset of **8.5** degrees -. The range of the offsets is **-50.0 (-500)** to **50.0 (500)**. The user can also enable or disable offsets for SSI Analog Input Boards. The options are **Yes** or **No**.

Parameter	Value		
Enable Offsets/SSI...	no	▲	▲
Mod. 1, Input 1	-500	▲	▲
Mod. 1, Input 2	0		
Mod. 1, Input 3	-255		
Mod. 1, Input 4	-425		
Mod. 1, Input 5	0		
Mod. 1, Input 6	0		
Mod. 1, Input 7	250		
Mod. 2, Input 8	25	▼	▼
Mod. 2, Input 9	0	▼	▼
Mod. 2, Input 10	0		
Mod. 2, Input 11	-36		
Mod. 2, Input 12	0		
		▼	Esc

### AUX SP Configuration

This menu is used to setup and assign a setpoint to be transmitted to a slave instrument. The Offset and Delay Time parameters are used to modify the setpoint and when it is sent to the slave instrument. This feature is limited to Slave Instruments 1, 2, and 3. This menu option is typically used to retransmit an alarm setpoint value to an overtemp controller.

The "Retrans to Slave 1", "Retrans to Slave 2", and "Retrans to Slave 3" menu options each have four options to select: **Off**, **Loop 1**, **Loop 2**, or **Loop 3**. These options will allow the user to select which, if any, values to retransmit to the selected slave instrument. The "Setpoint Offset Sl 1", "Setpoint Offset Sl 2", and "Setpoint Offset Sl 3" menu options can be a number between **-32768** and **32767**. These options will allow the user to set the destination offset for the selected slave instrument. The "Setpoint Delay Sl 1", "Setpoint Delay Sl 2", and "Setpoint Delay Sl 3" menu options can be a number between **-32768** and **32767**. These options will allow the user to set the delay, in seconds, before the setpoint is retransmitted to the selected slave instrument.

Parameter	Value	
Retrans to Slave 1	Loop 1	↑
Retrans to Slave 2	Loop 2	
Retrans to Slave 3	Off	
Setpoint Offset Sl 1	50	Enter
Setpoint Offset Sl 2	0	
Setpoint Offset Sl 3	0	
Setpoint Delay Sl 1	15	↓
Setpoint Delay Sl 2	0	
Setpoint Delay Sl 3	0	
		Esc

### Tuning Assistant

The Tuning Assistant menu option will allow the user to automatically generate the PID loop settings for the control loops in the 9210 Nitrider.

*Note: The four buttons at the bottom of the screen: **Accept Under Damped**, **Accept Critically Damped**, **Accept Over Damped**, and **Accept PI** will be inaccessible until some PID settings are loaded into the PID settings list above the buttons. The **Cancel** button in the bottom right of the screen will close down the screen. The user can select the loop to use from the drop down list next to "Loop" at the top of the screen. The loop choices are: **1**, **2**, or **3**. This will select the specific loop to perform the auto tune on.*

Enter the new value and press the **Enter** button to set the value. Pressing the **Esc** button will cancel the change.

The current value will be displayed at the top of the screen. The user can select the tuning option from the "Tuning" section on the top left of the screen. The choices are: **Relay** and **Lim. Relay** (Limited Relay). This option will allow the user to limit the output value while the controller is controlling the furnace. Normal operation will typically use 100 % output. When the limited relay option is selected, the "Tuning Delta:" label and the **Edit** button will be displayed. When the **Relay** option is selected, the "Tuning Delta:" label and the **Edit** button will be hidden. The "Tuning Delta:" value will be the amount to limit the controller by. Pressing the **Edit** button will display the numeric keypad, which will allow the user to enter the limiting value.

The current value will be displayed at the top of the screen.

The "Conservative" option will allow the user to minimize, if not remove, the possibility for an overshoot of the setpoint. If a small overshoot is acceptable, leave the "Conservative" checkbox unchecked. If, however, no overshoot is desired, then checking the "Conservative" checkbox will accomplish this.

Pressing the **Start** button will begin the auto tune process. *Note: The process may take a few seconds to start.* The "Idle" line will change to display the calibration process for the auto tune. The line will display a pointer value, along with the process variable value and the setpoint.

Tuning - Pointer:51 PV:1289/SP:1300

*Note: The **Start** button will be disabled while the calibration is running.* Pressing the **Abort** button will abort the process. If the **Cancel** button is pressed

while a calibration is running, a message box will be displayed confirming the action.

When the calibration is finished, the PID settings list will be populated with suggested values and the four buttons underneath will be enabled. The line above the PID settings list will read "Idle" again as well.

	Underdamp	Crit Damp	Overdamp	PI Only
P	1.2	1.8	2.4	1.3
I	3.69	1.84	1.23	1.10
D	0.10	0.13	0.13	

The user has the option to select only one of these sets of values: either the Under Damped set, the Critically Damped set, the Over Damped set, or the PI set. To select the set of values, press the corresponding button. For example, to select the Critically Damped set of values, press the **Accept Critically Damped** button. The under damped values will reach the setpoint faster, but there will be more

overshoot involved. The over damped values will work to minimize the overshoot, but it will be slower than the under damped values. The critically damped values are considered the "optimum" values because they are a balance between the under damped and over damped values with regards to time and overshoot. The PI values are just the proportional band and the reset value (the *P* and the *I* from *PID*). This could be applicable in an atmosphere loop, where the rate won't have much effect.

Once a set of values has been accepted, the user can press the **Cancel** button to exit the screen. The accepted values can be viewed on the *PID Loop Setup* menu option. *Note: Once the screen is closed out, the PID settings values will be lost.* To populate these values again, another calibration routine will need to be run.

### DF1 Configuration

This section will allow the user to set up the DF1 configuration settings.

#### My Node

This option will allow the user to select the node. This node must not exist anywhere else on the computer's network. The range is **0** to **30000**.

#### PLC node



This option will allow the user to select the PLC node. This must be the node address of a PLC. The range is **0** to **30000**.

#### PLC read table

This option will allow the user to select the PLC read table. The range is **8** to **255**.

#### PLC write table

This option will allow the user to select the PLC write table. The range is **8** to **255**.

Parameter	Value	
My node	6	 <b>Enter</b>  <b>Esc</b>
PLC node	1	
PLC read table	13	
PLC write table	12	
PLC msg dly (ms)	0	

**PLC msg Delay (ms)**

This option will allow the user to set the delay, in milliseconds. The range is **50** to **5000**.

## Chapter 4 – Configurator 2.0 Menus

The following section describes the menus that are found in SSI's Configurator 2.0 application that deal with the 9210 Nitrider.

(menu)

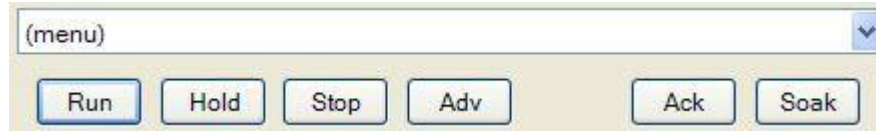

The *Menu* option will allow the user to control the recipes that are on the 9210 Nitrider. The area right below the drop-down menu list allows the

user to start, stop, hold, or resume a recipe.

Clicking on the **Run** button will display the *Run Recipe* screen, from which the user can select the recipe to run.

Use the number box next to the "Recipe" text to select a recipe number from 1 to 300. Once the recipe number has been selected, click on the **Load** button. This will display the steps in the recipe in the white area. If the user wants the recipe to start from a step other than step 1, the user can select which step from the number box to the right of the **Load** button. The user can edit the steps in the recipe just like in the *Recipe Management* screen.

*Note: This is an edit-once type of edit, and the changes won't be saved to the 9210.* Once the recipe number and the starting step number have been chosen, the user can click on the **Run** button. This will begin the recipe. If the user does not wish to run the recipe, clicking on the **Cancel** button will close the form without starting the recipe.

While a recipe is running, there will be a green highlight across the program display area.

	Opcode			Option
1	SETPT	1700		wait
2	SETPT	1700	1.00	wait
3	SOAK			0:01
4	EVT_OUT			3-ON
5	SETPT	1600		wait
6	DELAY			5
7	EVT_OUT			3-off
8	SETPT	1600	0.80	wait
9	SOAK			0:01
10	EVT_OUT			1-ON
11	ALARM			1
12	EVT_OUT			1-off

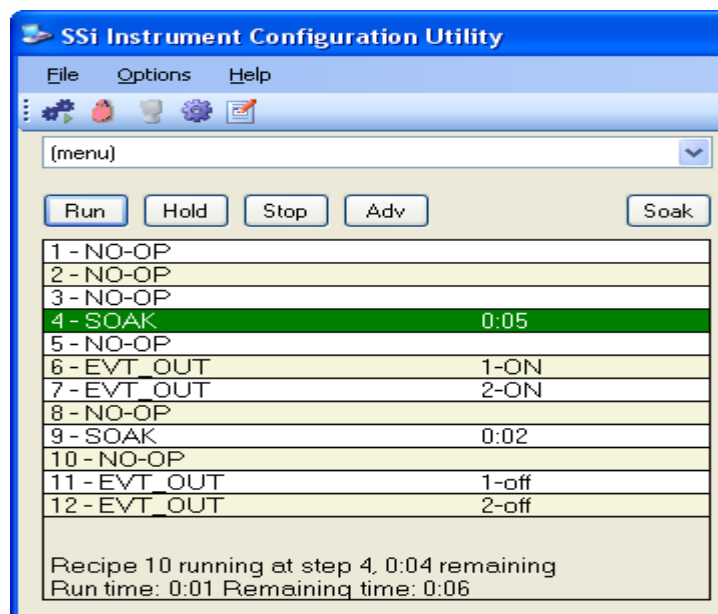

action.

The **Hold** button will put the recipe on hold, but it will not stop the recipe. To hold a recipe, click on the **Hold** button. The user will have to confirm the action.

Clicking on **Yes** will hold the recipe, and clicking on **No** will not hold the recipe. Once the program has been held, the **Hold** button will say **Cont**, there will be a yellow highlight across the program display.

To continue the recipe, click on the **Cont** button. The user will have to confirm the action

Click the **Yes** button to continue the recipe. Click the **No** button to leave the recipe in hold. Once the recipe has been continued, the green highlight will return and the **Cont** button will say **Hold**.

To stop the recipe, click on **Stop**. This will display a message box confirming the

Clicking on **Yes** will stop the program and clicking on **No** will cancel the action.

The **ADV** button will allow the user to advance to the next step in the recipe. The user will have to confirm the action.

Clicking on the **Yes** button will advance the recipe to the next step, while clicking on the **No** button will cancel the advance.

If there is an alarm of any kind, the alarm text will be displayed at the bottom of the program display area with a red highlight, and the **Ack** button will become visible.

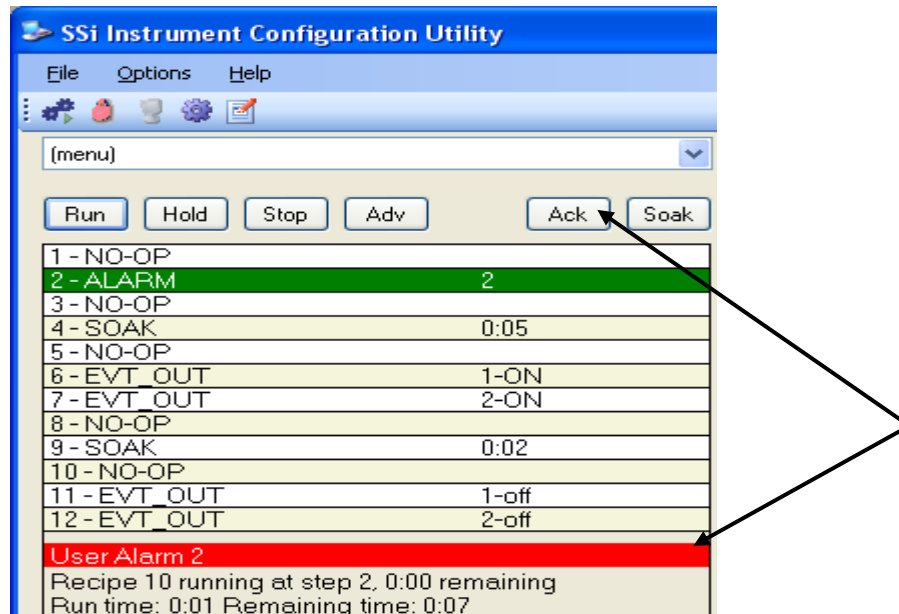

Clicking on the **Ack** button will acknowledge the alarm. Once the alarm has been acknowledged, the **Ack** button will disappear, and the alarm text will disappear as well.

The **Soak** button will allow the user to manually change the length of a soak time. To do this, click on the **Soak** button. *Note: The recipe must be in a soak step for this button to be enabled.* This will display the Soak Timer dialog box.

The current soak time will be displayed initially. To set a new soak time, change the hours and/or minutes to the desired values and click on the **Set** button. *Note: This change will only last for the current soak and will not be a permanent change.* To cancel the change, click on the **Cancel** button.

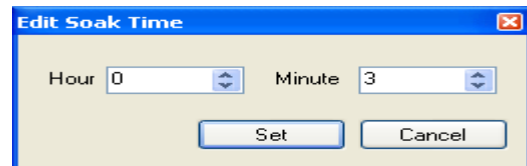



Slave Instruments

This page is a display of the current process variables of each of the slave instruments communicating with the 9200 dual loop controller. *Note: None of these values can be modified on this screen.* For set-up of the auxiliary instruments go to the menu item *Slave Instrument Setup*.

Parameter	Value
Instrument 1 [N/A]	0
Instrument 2 [OK]	73
Instrument 3 [N/A]	0
Instrument 4 [N/A]	0
Instrument 5 [OK]	9999
Instrument 6 [OK]	80
Instrument 7 [OK]	9999
Instrument 8 [N/A]	0
Instrument 9 [N/A]	0
Instrument 10 [N/A]	0
Instrument 11 [N/A]	0
Instrument 12 [OK]	0
Instrument 13 [N/A]	0
Instrument 14 [N/A]	0
Instrument 15 [N/A]	0
Instrument 16 [N/A]	0
Instrument 17 [N/A]	0
Instrument 18 [N/A]	0
Instrument 19 [N/A]	0
Instrument 20 [N/A]	0
Instrument 21 [N/A]	0
Instrument 22 [N/A]	0
Instrument 23 [N/A]	626
Instrument 24 [N/A]	28
Instrument 25 [N/A]	110

Auxiliary Analog Input

This menu option shows the process variables for the 3 analog inputs of the 9200 dual loop controller. It also shows the input types and any information from attached slave analog input modules. *Note: None of these values can be modified on this screen.*

Parameter	Value
Input 1	40.64
Input 2	-13.95
Input 3	9999
[M 1   volt   OK  0.0] TC 1	0.000
TC 2	0.000
TC 3	0.000
TC 4	0.000
TC 5	0.000
TC 6	0.000
TC 7	0.000
TC 8	0.000
[M 2   volt   OK  0.0] TC 9	0.000
TC 10	0.000
TC 11	0.000
TC 12	0.000
TC 13	0.000
TC 14	0.000
TC 15	0.000
TC 16	0.000
[M 3   volt   OK  0.0] TC...	0.000
TC 18	0.000
TC 19	0.000
TC 20	0.000
TC 21	0.000
TC 22	0.000
TC 23	0.000
TC 24	0.000
[M 4   volt   OK  0.0] TC...	0.000
TC 26	0.000

## Manual Event Control

Parameter	Value	
Event 0	off	
Event 1	off	
Event 2	off	
Event 3	off	
Event 4	off	
Event 5	off	
Event 6	off	
Event 7	off	
Event 8	off	
Event 9	off	
Event 10	off	
Event 11	off	
Event 12	off	
Event 13	off	
Event 14	off	
Event 15	off	
Turn off all events		
Turn ON all events		

The Manual Event Control menu option in the 9210 Nitrider shows the user all of the events (0 – 15) and their current status. It also allows the user to manually control the status of any event by clicking on the value. A single click will display an input box that will allow the user to select either an **On** value or an **Off** value.

Clicking on the **OK** button will set the value, while clicking on the **Cancel** button will cancel the action.

Clicking on the “Value” section of the “Turn off all events” field will force all of the events

to **Off** status. The user will have to confirm this action.

Clicking on the **Yes** button will set the action, while clicking on the **No** button will cancel the action.

Clicking on the “Value” section of the “Turn ON all events” field will force all of the events to **On** status. The user will have to confirm this action.

Clicking on the **Yes** button will set the action, while clicking on the **No** button will cancel the action.

### PID Loop Setup

PID is the tuning parameters entered for each Process Variable loop. The loop value can either be **Loop 1**, **Loop 2**, or **Loop 3**.

#### **Prop Band (0 for On/Off)**

This is the proportional band field. P = Proportional (Prop Band). This is a field in which you want to stay around the setpoint.

The range 0 – 999.0

#### **Reset**

This is the reset field. I = Integral (Reset). This is the actual temperature being monitored over a period of time and then averaged to keep within the Proportional band.

The reset is in repeats per minute. This affects the output of the controller. It will be proportional to the amount of time the error is present. This helps to eliminate offset.

The range 0 – 100.00

Parameter	Value
Prop Band (0 for On/Off)	1.3
Reset	0.01
Rate	0.00
Mode	Dual Direct
Integral Preset	0
Cycle Time	24
Setpoint Change Limit	OFF
Low Limit	-100
High Limit	100
0 set point stops control	no
IN1 high limit shuts down ctrl	no
IN2 high limit shuts down ctrl	no
IN3 high limit shuts down ctrl	no
PID auto switch	no
Switch Point PID 1->2	99.99
Switch Point PID 2->3	99.99
Overshoot limit gain	0
Deviation setpoint	Off
Dev. Alarm delay (sec)	0
Setpoint Lower Limit	-99.99
Setpoint Upper Limit	299.99

#### **Rate**

This is the rate field. D = Derivative (Rate). This is the sudden change or rate in the temperature. This rate is in minutes. This affects the controller output which is proportional to the rate of change of the measurement and will control the amount of output by time restraints. Thus derivative takes action to inhibit more rapid changes of the measurement than proportional action. Derivative is often used to avoid overshoot.

The range is 0 – 100.00. The rate is not typically used for heating/carbon

#### **Mode**

This is the mode of the loop.

The values are: Dual Reverse, Single Reverse, Dual Direct, or Single Direct.

Dual – This has two output relays which can increase and decrease to achieve your SP.

Single – This has one relay which works in only one direction to achieve your SP.

Direct - If the PV - SP equals a positive number and the output would bring the PV down toward setpoint that is direct.

Reverse – If the PV - SP equals a negative number and the output would bring the PV up toward setpoint then that is reverse

Example: If a 12 mA output drives a 0 degree F temp. (PV) up to a 1200 degree F temp. (SP) this would be REVERSE and since this would take a SINGLE output from the controller the Mode for the Temperature Loop is Single Reverse.

#### **Integral Preset**

This field provides an offset for the starting point for PID control, also referred to as “Load Line” or “Manual Reset”. The range is –100 to 100.

### **Cycle Time**

This field is typically set to the valve travel time multiplied by 1.5.

### **Setpoint Change Limit**

This is a smart time feature that allows Process Loop to use PB only without Reset until the Process Variable drops below the percent output set under this category.

It is used to eliminate overshoot.

The Output percentage selected under this category *must* be above the normal operating output percentage of the furnace at heat.

Example – if the furnace runs at 40% output at heat for the maximum load, the setpoint change limit should be set to 60%.

### **Low Limit**

This is the low limit field. The range is –100 to 100.

### **High Limit**

This is the high limit field. The range is –100 to 100.

### **0 Setpoint Stops Control**

If the Setpoint is zero, then all outputs are turned off. The option is either Yes or No.

### **IN1 high limit shuts down ctrl**

If input 1's high limit is reached, then all outputs are turned off. The value can either be Yes or No.

### **IN2 high limit shuts down ctrl**

If input 2's high limit is reached, then all outputs are turned off. The value can either be Yes or No.

### **IN3 high limit shuts down ctrl**

If input 3's high limit is reached, then all outputs are turned off. The value can either be Yes or No.

### **PID Auto Switch**

This is the PID auto switch field. The value can either be Yes or No.

### **Switch Point PID 1 -> 2**

This is the PID Switch Point field. The range is –300 to 4000.

### **Switch Point PID 2 -> 3**

This is the PID Switch Point field. The range is –300 to 4000.

### **Overshoot Limit Gain**

This is the Overshoot limit gain field. When calculating the control action sometimes the calculation would call for more than 100% which is not possible. The output is limited to 100%, or whatever was set in the High Limit field. The difference of the unlimited minus the limited is multiplied by the over shoot limit gain and divided by 100. This is subtracted from the control output. If the gain is 0 there is no effect. Under normal control the unlimited equals the limited and there is no effect. If there is a big change where the control loop drives hard, then the effect is to limit the drive as it approaches setpoint and limit the overshoot.

The limited is the values set in the upper and lower limits fields. The unlimited would be what is calculated before limiting. For a big setpoint change, the calculations may compute 150% output, but the true output is limited to the upper limit.

The range is 0 to 9999.

### **Deviation Setpoint**

This will set the deviation alarm setpoint. The range is **0.00 (OFF)** to **32000.00**.

**Dev. Alarm Delay (Seconds)**

This will set the delay in seconds before the deviation alarm becomes active. The range is **0** to **32000**.

**Setpoint Lower Limit**

This is the setpoint lower limit for the loop. The range is -9999 to 9999.

**Setpoint Upper Limit**

This is the setpoint upper limit for the loop. The range is -29999 to 29999.

**Factory Default Configuration:**

Loop 1 (Kn/Dissoc)

LP 1 Prop Band (DB ON/ OFF)	1.3
LP 1 Reset	0.01
LP 1 Rate	0.00
LP 1 Mode	Dual Direct
LP 1 Integral Preset	0
LP 1 Cycle Time	24
LP 1 Setpoint Change Limit	OFF
LP 1 Low Limit	-100
LP 1 High Limit	100
LP 1 Zero SP stops control	No
LP 1 IN1 High Limit shuts down control	No
LP 1 IN2 High Limit shuts down control	No
LP 1 IN3 High Limit shuts down control	No
LP 1 PID Auto Switch	No
LP 1 Switch Point PID 1 -> 2	99.99
LP 1 Switch Point PID 2 -> 3	99.99
LP 1 Overshoot Limit Gain	0
LP 1 Deviation Setpoint	OFF
LP 1 Dev. Alarm delay (seconds)	0
LP 1 Setpoint Lower Limit	-99.99
LP 1 Setpoint Upper Limit	299.99

Loop 2 (Temperature)

LP 2 Prop Band (DB ON/ OFF)	20.0
LP 2 Reset	0.10
LP 2 Rate	0.00
LP 2 Mode	Single Reverse
LP 2 Integral Preset	0
LP 2 Cycle Time	60
LP 2 Setpoint Change Limit	80 %
LP 2 Low Limit	0
LP 2 High Limit	100
LP 2 Zero SP stops control	No
LP 2 IN1 High Limit shuts down control	No
LP 2 IN2 High Limit shuts down control	No

LP 2 IN3 High Limit shuts down control	No
LP 2 PID Auto Switch	No
LP 2 Switch Point PID 1 -> 2	9999
LP 2 Switch Point PID 2 -> 3	9999
LP 2 Overshoot Limit Gain	0
LP 2 Deviation Setpoint	N/A
LP 2 Dev. Alarm delay (seconds)	N/A
LP 2 Setpoint Lower Limit	-9999
LP 2 Setpoint Upper Limit	29999

Loop 3 (Backpressure)

LP 3 Prop Band (DB ON/ OFF)	4.0
LP 3 Reset	0.10
LP 3 Rate	0.00
LP 3 Mode	Single Reverse
LP 3 Integral Preset	0
LP 3 Cycle Time	60
LP 3 Setpoint Change Limit	OFF
LP 3 Low Limit	0
LP 3 High Limit	100
LP 3 Zero SP stops control	No
LP 3 IN1 High Limit shuts down control	No
LP 3 IN2 High Limit shuts down control	No
LP 3 IN3 High Limit shuts down control	No
LP 3 PID Auto Switch	No
LP 3 Switch Point PID 1 -> 2	99.99
LP 3 Switch Point PID 2 -> 3	99.99
LP 3 Overshoot Limit Gain	0
LP 3 Deviation Setpoint	OFF
LP 3 Dev. Alarm delay (seconds)	0
LP 3 Setpoint Lower Limit	-99.99
LP 3 Setpoint Upper Limit	299.99

Event Run Program Setup

Parameter	Value
Program number to run	0

Event run program setup is used to start a program that is stored in the 9210 Nitriding controller (zero for buffered) or by a defined event input.

\*Program must be configured under the menu option *Event Control*

\*Used to define an event input to initiate a program start and to define which program to start (zero starts the last program run) from the contact closure. The range of programs to run is **0** to **300**.

**\*WARNING\***

If a JUMP (to another program) is used in a previous program, the program that will run would be the last program jumped to not the first program run.

If you stop a program in a GOSUB the program that will be run will be the GOSUB.

Zone/Load TC Setup

Configuration of any analog input device must be completed with this menu item.

**Load TC Enable**

This value will manually toggle between **on**, **on + alarms**, and **off**.  
 On – T/C Enabled  
 On + alarms – T/C Enabled, Programmer alarm114 provided if out of band (Default wait limits)  
 Off – T/C not enabled

**Control TC**

This value allows the user to set the TC to be part of the group of Load TCs that can hold the program if it is out of band. The values are **active** or **not active**, shown as blank

**TC 1 - 24**

This value allows the user to manually turn the T/C from **active** to **not active**, shown as blank, to be part of the group of TCs that can hold the program if it's out of band.

Parameter	Value
Load TC Enable	on + alarms
Control TC	
TC 1	active
TC 2	
TC 3	
TC 4	
TC 5	
TC 6	active
TC 7	
TC 8	
TC 9	
TC 10	
TC 11	
TC 12	
TC 13	
TC 14	
TC 15	
TC 16	
TC 17	
TC 18	
TC 19	
TC 20	
TC 21	
TC 22	
TC 23	
TC 24	

Port Setup

Parameter	Value
Host 232 Baud	19200
Host 232 Mode	Modbus master/PLC
Host 485 (3,4) Baud	19200
Host 485 (3,4) Mode	Modbus
Host 485 Address	1
Slave 1 (5,6) Baud	19200
Slave 1 (5,6) Mode	Modbus Host
Slave 2 (22,23) Baud	19200
Slave 2 (22,23) Mode	Modbus
232/H2 Port Baud	9600
PLC Type	Micrologix Modbus

Port setup is the communications definitions for the controller. Please contact Super Systems Inc. for more information regarding port setup. It is *strongly recommended* that none of the settings be modified without technical support from Super Systems Inc. Clicking on any of the values will display an input box that will allow the user to modify the current settings.

### Slave Instrument Setup

\*\* All devices on the same slave port must utilize the same protocol  
 \*\* An address of zero (0) will disable the instrument\*\* Some controllers (AC20 for example) can provide dual functions (atmosphere and events) and must have the same address assigned for both.

Clicking on the "Value" field for any instrument will allow the user to select the slave instrument.

#### Instrument

This value will allow the user to select the slave instrument type.

Parameter	Value
Instrument 1	
Instrument 2	
Instrument 3	
Instrument 4	
Instrument 5	
Instrument 6	
Instrument 7	AEC Flow Board @ 21 on sl...
Instrument 8	AEC Flow Board @ 22 on sl...
Instrument 9	AEC Flow Board @ 23 on sl...
Instrument 10	
Instrument 11	
Instrument 12	
Instrument 13	
Instrument 14	
Instrument 15	
Instrument 16	
Instrument 17	
Instrument 18	
Instrument 19	
Instrument 20	Micrologix PLC @ 1 on RS-...
Instrument 21	Micrologix PLC @ 1 on RS-...
Instrument 22	Micrologix PLC @ 1 on RS-...
Instrument 23	
Instrument 24	
Instrument 25	Micrologix PLC @ 1 on RS-...

### Atmosphere Controllers

*Some Atmosphere controllers will have an [A] in front of the name*

SSI AC20	Eurotherm 2404	MGA
Yokagowa 750	Eurotherm 2500	
Honeywell UDC 3300	Carbpro v3.5	



Dualpro LP1 modbus	Carbpro v3.0
Dualpro LP2 modbus	Carb PC
Dualpro LP1 MMI	9200 LP1
Dualpro LP2 MMI	IR Base

### Temperature Controllers

*Some Temperature controllers will have a [T] in front of the name*

SSi 7EK	9200 LP1	SSi Quad A01
Yokogawa 750	9200 LP2	SSi Quad A02
Honeywell UDC 3300	9200 LP3	SSi Quad A03
Dualpro LP1 modbus	9100 LP2	SSi Quad A04
Dualpro LP2 modbus	Eurotherm 2704 LP1	Yokogawa UT350
Dualpro LP1 MMI	Eurotherm 2704 LP2	Yokogawa 750 LP 2
Dualpro LP2 MMI	Eurotherm 2704 LP3	Yokogawa UP350
Eurotherm 2404	VC base 1	Honeywell DCP551
Eurotherm 2500	VC base 2	Ascon 08
Unipro v 3.5	VC base 3	SSi X5
Unipro v 3.0	VC base 4	SSi M4L
Carbpro v3.5 slave	AIPC	SSi X5/Timer
Carbpro v3.0 slave	SSI 7SL	
10pro	AEC Flow Board	
Dualpro in C	UMC800 LP1	

### Event controllers

SSI AC E	Micrologix PLC	User 7
Yokogawa 750E	MCM Module	User 8
Mod Mux	PLC5 DF1	User 9
Dualpro E Modbus	SLC DF1	User 10
Dualpro E MMI	User 1	User 11
Carbpro E v3.5	User 2	User 12
Carbpro E v3.0	User 3	User 13
Eurotherm 2500	User 4	User 14
Ssi 8-8	User 5	User 15
SSi 9200 E	User 6	User 16

### Address

This value allows the user to select the address that corresponds with the controller selected, with a range of 0 to 249.

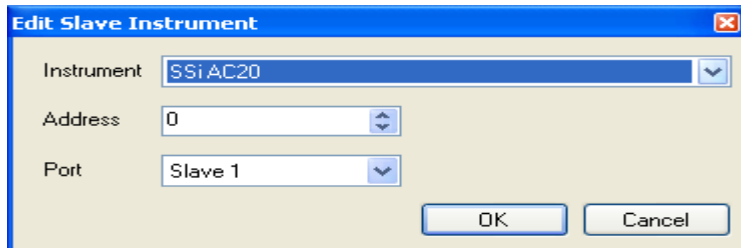

### Port

The options for this field can either be **Slave 1**, **Slave 2**, or **RS-232**.

Slave 1 – terminals 5(-), 6(+)

Slave 2 – terminals 22(+), 23(-)

### Zone Assignments

A zone assignment on the 9210 Nitrider allows the recipe programs to change setpoints on all slave instruments of a multi-zone furnace (up to five (5) zones).

\*Only used when running recipes

\*Slave Instrument Setup must be configured prior to Zone Assignment setup

\*\* Atmosphere zones link instruments to Atmosphere Setpoints

\*\* Temperature zones link instruments to Temperature Setpoints

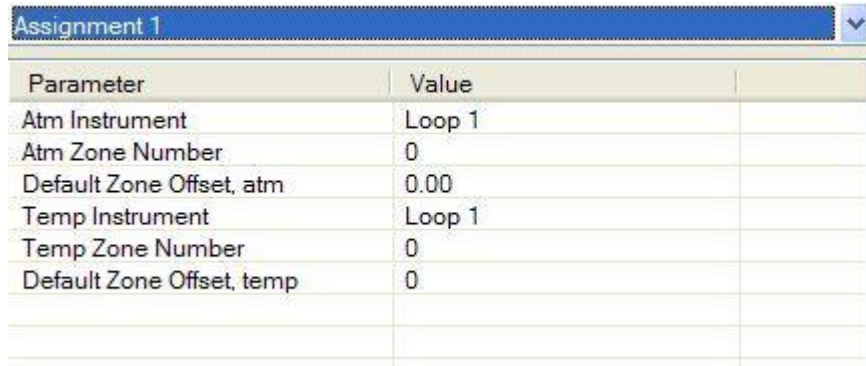

Parameter	Value
Atm Instrument	Loop 1
Atm Zone Number	0
Default Zone Offset, atm	0.00
Temp Instrument	Loop 1
Temp Zone Number	0
Default Zone Offset, temp	0

### Assignments

The zone assignment number, with a choice of Assignment 1 through Assignment 5.

### ATM Instrument Number

The slave instrument number assigned to an atmosphere controller, with a range of **Loop 1 – Loop 3**, and **Instrument 1 – Instrument 25**.

### ATM Zone Number

The zone within which the atmosphere setpoint change is desired, with a range of **0 to 5**.

### Default Zone Offset, atm

This is the default zone offset for atmosphere, with a range of **-100.00 to 100.00**.

### Temp Instrument Number

The slave instrument number assigned to a temperature controller, with a range of **Loop 1 – Loop 3**, and **Instrument 1 – Instrument 25**.

### Temp Zone Number

The zone within which the temperature setpoint change is desired, with a range of **0 to 5**.

### Default Zone Offset, temp

This is the default zone offset for temperature, with a range of **-32000 to 32000**.

## Furnace Setup

The Furnace Setup menu option is an administrative access only option. Do not make any adjustments on this screen without first contacting Super Systems Inc.

Parameter	Value
PVT Type	Nitrider
Nitrider Mode	NH3 and Nit. Potential
Nitrider Control	control
H2 Cell Type	Hi
H2 RS-232 Comms	yes
Temperature Display	internal
lp3 control	Backpressure
Valve 1 (Nitrogen)	yes
Valve 2 (Ammonia)	yes
Dissociated Ammonia	yes
Hydrogen	no
Temperature Mode	°F
Programmer Type	Nitrider
Atmosphere Instrument	Loop 1
Temperature Instrument	Loop 2
Event Instrument	Instrument 11
Quench Instrument	Instrument 13
End of quench event	0
Quench speed event	0
Quench run event	0
Nitrider Bias	0.0
Date and Time	9/16/2010 4:07:42 PM
Default Hold Time (min)	90
Deviation Alarm Delay (min)	0
PLC Type	Micrologix Modbus
Flow Signal	Digital/485
Clear Events, end of recipe	no

### PVT Type

The PVT type is the mode the device runs in (Carbon, Dewpoint, etc.). The mode selected determines the calculations and scaling for the Process Variable. This option is fixed at **Nitrider**.

### Nitrider Mode

This option will determine the type of nitriding that will be done. The list of options is:

**H2 and Dissociation**  
**NH3 and Dissociation**  
**H2, NH3 and Dissociation**  
**H2, NH3 and Nit. Potential**  
**H2 and Nit. Potential**  
**NH3 and Nit. Potential**  
**H2 and H2 Control**  
**NH3 and NH3 Control**  
**H2 and Dissociation**  
**Reserved**  
**Reserved**  
**Reserved**  
**H2 and Super Kn**

### Nitrider Control

This option will determine the type of

nitriding control. The options are **Control** or **Monitor**.

### H2 Cell Type

This option will determine the type of H2 cell used. The options are: **Hi** or **H2**.

### H2 RS-232 Comms

This option will determine if the H2 comms are over RS-232. The options are **Yes** or **No**.

### Temperature Display

This will determine the temperature display. The options are **Internal** or **SPP Instrument**.

### LP3 Control

This option will determine the type of control that loop 3 does. The options are: **None**, **BP (Backpressure)**, **N/A**, or **Temp**.

### Valve 1 (Nitrogen)

This option will determine if valve 1 is used. The options are **Yes** or **No**.

### Valve 2 (Ammonia)

This option will determine if valve 2 is used. The options are **Yes** or **No**.

### Dissociated Ammonia

This option will determine if Dissociated Ammonia is used. The options are **Yes** or **No**.

### **Hydrogen**

This option will determine if Hydrogen is used. The options are **Yes** or **No**.

### **Temperature Mode**

This value determines the specific temperature scale to be used. It can be either Degrees **°F** or degrees **°C**.

### **Programmer Type**

Displays programmer types and allows for a change in control mode. The values for the Programmer Type are: **% Carbon, Dew Point, % O2, Millivolts, Temperature Only, Dual Temperature, Vacuum, Probe + IR, Nitrider, Carbon + Dual Temperature, or Cascade**.

### **Atmosphere Instrument**

Allows for a slave instrument (or internal) to be the defined atmosphere control device. The types of instruments are: **Internal Loop 1 – Internal Loop 3, Instrument 1 – Instrument 25**.

### **Temperature Instrument**

Allows for a slave instrument (or internal) to be the defined temperature control device. The types of instruments are: **Internal Loop 1 – Internal Loop 3, Instrument 1 – Instrument 25**.

### **Event Instrument**

Allows for a slave instrument (or internal) to be the defined event control device. The types of instruments are: **Internal, Instrument 1 – Instrument 25**.

### **Quench Instrument**

Allows for slave instrument (or internal) to be the defined quench control device. The types of instruments are: **Internal Loop 1 – Internal Loop 3, Instrument 1 – Instrument 25**.

### **End of Quench Event**

Tells the programmer which event to signal end of quench (related to which relay it is assigned). The list of possible values is: **0 – 14**.

### **Quench Speed Event**

Tells the programmer which event will signal the quench speed. The list of possible values is: **0 – 14**.

### **Quench Run Event**

Tells the programmer which event will signal quench run. The list of possible values is: **0 – 14**.

### **Nitrider Bias**

This option will allow the user enter the Nitrider bias. The range is **-100.00** to **100.00**.

### **Date and Time**

This value is the current date and time on the 9210 controller only (not the local computer or the touch screen, if applicable). Clicking on the "Value" column will allow the user to set a new date and time on the controller. *Note: To change the date/time of the Touch Screen, see Appendix 3 – Changing the Date/Time of the Touch Screen Display.*

### **Default Hold Time**

This value is the default holding time for the furnace. The range is **0** to **10000**.

### Deviation Alarm delay

This value is the delay for the alarm if a deviation alarm is detected. The range is 0 to 10000.

### PLC Type

This option will determine the type of PLC being used. The options are:

- Micrologix Modbus
- MCMmodule Modbus
- DF1 PLC5
- DF1 Slik

### Flow Signal

This option will determine the type of flow signal being used. The options are **Analog/PLC** or **Digital/485**.

### Clear Events, End of Recipe

This option will determine if all of the events should be cleared when a running recipe ends. The options are **Yes** or **No**.

### Default Wait Limits

The 9210 Nitrider uses default wait limits in conjunction with recipe programs. The wait limits are in place to help make sure a recipe will not continue to the next step until the temperature, atmosphere or both are within the specified range. The wait limits are both plus and minus the value of the setpoint specified in the recipe. You can define specific wait limits per program that supersede the defaults with the specific wait limit OP CODE per program (SETWAIT).

Parameter	Value
Temp Wait Limit	15
Atm Wait Limit	1.0

### Factory Default configuration

- Temp Wait Limit – 15
- Atm Wait Limit – 1.0

### Furnace Name

Parameter	Value
Furnace Name	Nitrider
PV1 Name	Dissociation
PV2 Name	Temperature
PV3 Name	Back Pressure

This page allows the user to enter a furnace name and the process variable (PV) names you wish to be displayed. Therefore, Loop 1 will be displayed as Dissociation. Clicking on any of the values will display an input box. The user can enter the desired text then press **OK**. All

values have a maximum length of twenty (20) characters.

### Alarm Setup

The 9210 Nitrider can be configured to use three

Alarm 1	
Parameter	Value
Setpoint	1.00
Alarm Type	PV1 proc high
Hysteresis	1
Smart Alarm	disabled
ON Delay Time (sec)	0

different alarms and a Thermocouple Check Alarm. Each of the alarms consists of an alarm setpoint, alarm type, alarm hysteresis, smart alarm, and ON delay time. The alarms come from the factory with a default configuration dependent on the application but also can be modified prior to shipment to your facility or in the field by a supervisor.

### **Setpoint**

This value is the setpoint for the alarm. Clicking on this value will display an input box from which the user can select a new value. The range is from -9999.00 to 9999.00.

### **Alarm Type**

This value is the type of alarms used. Clicking on this value will display an input box with two (2) drop-down lists from which the user can select a new value.

The values in the first (top) list box are:

- PV 1 Value**
- PV 2 Value**
- PV 3 Value**
- Input 1 Value**
- Input 2 Value**
- Input 3 Value**
- P01 Value**
- P02 Value**
- P03 Value**

The values in the second (bottom) list box are:

- Process High**
- Process Low**
- Out of Band**
- In Band**
- Outside Deviation**
- Within Deviation**

The process high alarm condition is when the PV is above the alarm setpoint; and process low means the alarm condition is when the PV is below the alarm setpoint.

Example: The 1400 deg contact is used to indicate when it is safe to add gas. Therefore you would want to set it as proc low with relay being normally closed (when no alarm). Then when it reaches a PV below 1400 deg. The alarm comes on and then the relay becomes an open. So if power were to fail this would not keep the relay energized.

### **Hysteresis**

This value is the Hysteresis value. The Hysteresis is a set number that works with the alarm to help control a motor or pump longer to reach a set amount to come back into band before it will shut off motor or pump.

Example: Using quench oil as an example, suppose the SP is 200 °F. The alarm is set as a deviation of +10 °F. At 210 °F, the alarm is active and the pump will run to cool the oil. With a hysteresis of 8 °F, the alarm and pump will turn off at 202 °F. It will turn back on when it is 10 °F above setpoint. If the setpoint is still 200 °F, then at 210 °F, it will turn on again.

Clicking on this value will display an input box from which the user can select a new value. The range is from 0 to 9999.

### **Smart Alarm**

This value is a display of the Smart Alarm status. A smart alarm is an alarm that works with a Process Variable (PV), and, when enabled, it will not be active until the PV is within band of the setpoint. The alarm sounding - if active - will be disabled until within the SP band. When it is in band, the alarm will go active unless on delay time is set.

Example: If the SP is 1700 and the band is 10 degrees the alarm will not be active until the PV reaches 1690.

The value can be either **disabled** or **enabled**.

### ON Delay Time

This value is the ON Delay Time timer. If the timer is utilized, the alarm will not be active until the PV goes in band and activates the Smart alarm and then out of band and the timer has timed out (this is in seconds).

Example: If you select 30, the output will not energize until 30 seconds after the alarm is active. Clicking on this value will display an input box from which the user can select a new value. The range is from **0** to **9999**.

### Thermocouple Check

#### Source 1 – Source 3

This will set the source for the T/C Check. The list of options are:

Not Used	Instrument 11	Instrument 22
Instrument 1	Instrument 12	Instrument 23
Instrument 2	Instrument 13	Instrument 24
Instrument 3	Instrument 14	Instrument 25
Instrument 4	Instrument 15	Instrument 26
Instrument 5	Instrument 16	Instrument 27
Instrument 6	Instrument 17	N/A
Instrument 7	Instrument 18	Input 3
Instrument 8	Instrument 19	Input 2
Instrument 9	Instrument 20	Input 1
Instrument 10	Instrument 21	

### Tolerance Band

This option will set the tolerance band for the T/C Check. The range is **-9999** to **9999**.

### Source 2 Offset

This option will set the offset used with Source 2. The range is **-9999** to **9999**.

### Source 3 Offset

This option will set the offset used with Source 3. The range is **-9999** to **9999**.

### Default Configuration

<i>Parameter</i>	<i>Value</i>
Alarm 1 Setpoint	1.00
Alarm 1 Type	PV1 Process High
Alarm 1 Hysteresis	1
Alarm 1 Smart Alarm	Disabled
Alarm 1 ON Delay Time	0
Alarm 2 Setpoint	1400
Alarm 2 Type	PV2 Process High

Alarm 2 Hysteresis	10
Alarm 2 Smart Alarm	Disabled
Alarm 2 ON Delay Time	0
Alarm 3 Setpoint	1400
Alarm 3 Type	PV2 Process High
Alarm 3 Hysteresis	1
Alarm 3 Smart Alarm	Disabled
Alarm 3 ON Delay Time	0
T/C Check Source 1	Not Used
T/C Check Source 2	Not Used
T/C Check Source 3	Not Used
T/C Check Tolerance Band	0
T/C Check Source 2 Offset	0
T/C Check Source 3 Offset	0

**Standard Setup for DA Alarm with Delays**

DA is usually set up as PV 1 (Loop 1)

8.00 = 8% D.A.

Parameter	Value
Setpoint	8.00
Alarm Type	PV1 Band NO (Out of Band)
Hysteresis	1
Smart Alarm	Disabled
ON Delay Time (sec)	3600

Relay Assignments

Parameter	Value
Relay 1	event 0
Relay 2	event 1
Relay 3	event 2
Relay 4	event 3
Relay 5	event 4
Relay 6	event 5
Relay 7	loop 1 rev
Relay 8	programmer alarm

The 9210 Nitrider has the option of using eight relay outputs. All of the relays have a positive common terminal and independent negative terminals. All of the relays are configured in a normally closed position except relay number eight, which has both a normally closed (NC) and a normally open (NO) terminal. These relays can be configured to work with events, alarms, loops, and alarm combinations.

**Relay Output Terminals**

- Relay Output 1 – terminals 7 and 8
- Relay Output 2 – terminals 7 and 9
- Relay Output 3 – terminals 7 and 10
- Relay Output 4 – terminals 7 and 11
- Relay Output 5 – terminals 7 and 12
- Relay Output 6 – terminals 7 and 13
- Relay Output 7 – terminals 7 and 14
- Relay Output 8 – terminals 7 and 15 NC
- Relay Output 8 – terminals 7 and 16 NO



**Relay Output Choices**

Loop1 fwd	Event 3	burnoff
Loop1 rev	Event 4	IN1 relay SP A
Loop2 fwd	Event 5	IN1 relay SP B
Loop2 rev	Event 6	IN1 relay SP C
Loop3 fwd	Event 7	IN2 relay SP A
Loop3 rev	Event 8	IN2 relay SP B
Programmer alarm	Event 9	IN2 relay SP C
Alarm 1	Event 10	IN3 relay SP A
Alarm 2	Event 11	IN3 relay SP B
Alarm 3	Event 12	IN3 relay SPC
Event 0	Event 13	alarm combination
Event 1	Event 14	N/A
Event 2	Event 15	

The "Alarm Combination" option will allow the user to select the specific combination of alarms to use.

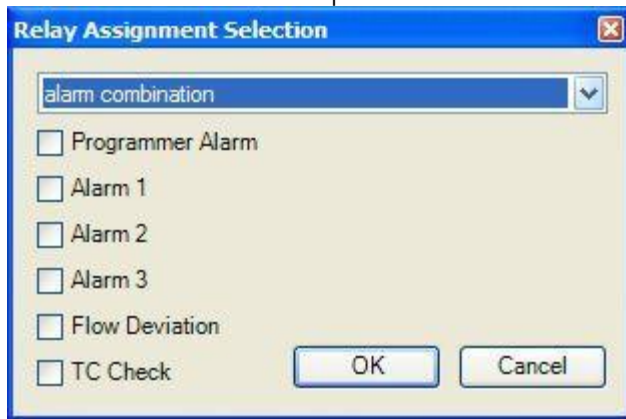

**Default Configuration**

Relay Output 1	Event 0
Relay Output 2	Event 1
Relay Output 3	Event 2
Relay Output 4	Event 3
Relay Output 5	Event 4
Relay Output 6	Event 5
Relay Output 7	Loop 1 Reverse
Relay Output 8	Programmer Alarm

Relay Setpoints

This option is typically used for vacuum applications.

The 9210 Nitriding offers the user three pairs of configurable vacuum setpoints for each input. Each pair of setpoints allows the user to configure both **ON** and **OFF** trigger points. The values entered are in engineering units based on input configuration.

The relay setpoints can only be used once the relays are assigned as such in the *Relay Assignments* menu option.

The range is **-32768** to **32767**.

Parameter	Value
Relay ON SP for IN1 A	0
Relay OFF SP for IN1 A	0
Relay ON SP for IN1 B	0
Relay OFF SP for IN1 B	0
Relay ON SP for IN1 C	0
Relay OFF SP for IN1 C	0
Relay ON SP for IN2 A	0
Relay OFF SP for IN2 A	0
Relay ON SP for IN2 B	0
Relay OFF SP for IN2 B	0
Relay ON SP for IN2 C	0
Relay OFF SP for IN2 C	0
Relay ON SP for IN3 A	0
Relay OFF SP for IN3 A	0
Relay ON SP for IN3 B	0
Relay OFF SP for IN3 B	0
Relay ON SP for IN3 C	0
Relay OFF SP for IN3 C	0

Analog Input Setup

Input 1	
Parameter	Value
Input Type	78.125 volts
Filter Time	0
Initial Scale	0.00
Full Scale	40.65
Decimal Point Location	2
Open TC	up scale
Input Offset	0.00
Trip Point 1 Setpoint	0.00
Trip Point 1 Force Value	0.00
Trip Point 1 Direction	input above setpoint
Trip Point 2 Setpoint	0.00
Trip Point 2 Force Value	0.00
Trip Point 2 Direction	input above setpoint
High Input Limit Setpoint	99.99
High Input Limit Hysteresis	0.01

The 9210 Nitriding has three analog inputs. Each of the inputs comes with a factory default configuration dependent on the application. It can be modified prior to shipment to your facility or in the field by a technician or qualified/trained person with the proper security code.

**Analog Input Terminals**

- Analog Input 1 – terminals 31(-) and 32(+)
- Analog Input 2 – terminals 29(-) and 30(+)
- Analog Input 3 – terminals 27(-) and 28(+)

**Parameter Definitions**

**Input Type**

The thermocouple type for most applications can be modified depending on your specific needs. Please note that in some applications, some of the inputs DO NOT allow the user to modify the Input type. To change the Input type, first select which input you want to change by selecting it in the pull-down menu just below the main menu list. Clicking on the Value will display an input box, and then you can use the pull-down menu to select the desired parameter. Once selected, click *OK* and the displayed Input type under Value will be the current type. The following is a list of the options:

B	S	12.5 volts **
C	T	781.25mv
E	2.5 volts	195.3125 mV

J	1.25 volts
K	78.125 mV
N	19.53125 mV
NNM	4-20 mA *
R	25 volts **

\* - When the specified input type is selected, a 124 Ohm resistor will need to be placed on that specific input's terminals for reading this selection. If resistor is not placed on input, then damage could occur to the board.

\*\* - When the specified input type is selected, a jumper located inside the case will need to be placed on that specific input for reading this selection. If jumper is not placed on input, then damage could occur to the board.

#### Filter time

The filter time is a factory applied averaging tool used to help maintain steady control in high EMI environments. The filter time should not be adjusted with consulting SSI. Clicking on this value will display an input box from which the user can select a new value. The range is **0** to **32767**.

#### Initial Scale

This is the initial scale value. Clicking on this value will display an input box from which the user can select a new value. The range is **-32768** to **32767**.

#### Full scale

This is the full scale value. Clicking on this value will display an input box from which the user can select a new value. The range is **-32768** to **32767**.

#### Decimal Point Location

This is the decimal point location value. Clicking on this value will display an input box from which the user can select a new value. The range is **0** to **4**.

#### Open TC

This is the open TC value. Clicking on this value will toggle between **up scale**, **down scale**, **one trip point**, and **two trip points**.

#### Input Offset:

The input offset value is algebraically added to the input value to adjust the input curve on read-out. The range is **-5000.00** to **5000.00**.

**TRIP POINT EXPLANATION:** Setting a trip point will force the value that the controller uses for calculations to a certain value as assigned by the operator. Once the **Trip Point Setpoint** is reached, the controller will begin reading the value as the **Trip Point Force Value**, regardless of what the actual value is inside the furnace. The **Trip Point Direction** allows the operator to choose whether the controller will alter its reading when the trip point is either above or below the setpoint.

**Trip Point 1 Setpoint:** This is the value at which the trip point will be activated, forcing the displayed value to the "force value" set below. This value must be something that the input can achieve.

**Trip Point 1 Force Value:** This is the value that the input will be forced to display when the trip point SP (set above) has been achieved.

**Trip Point 1 Direction:** This is the trip point 1 direction. Options are **input above setpoint** or **input below setpoint**.

If you choose **input above SP** then the PV for the selected input will need to transition above the Trip Point 1 SP value set above.

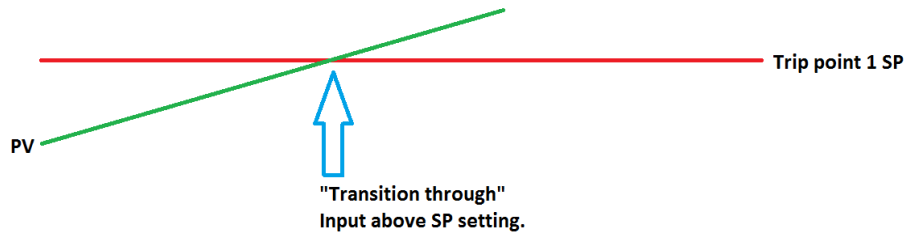

If you choose **input below SP** then the PV for the selected input will need to transition below the trip point SP value set above.

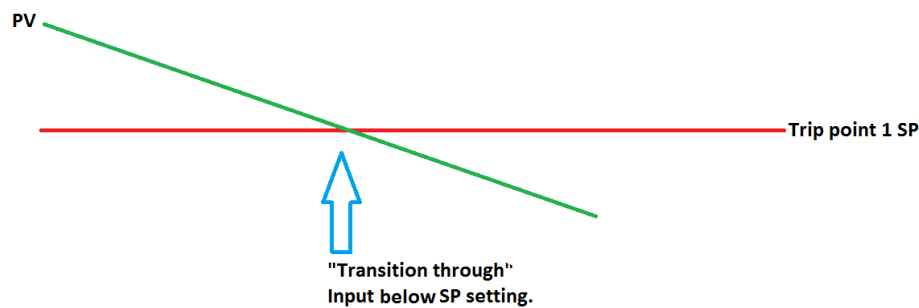

Example (when OPEN INPUT is set for 1 trip point):

Open Input	one trip point
Trip Point 1 Setpoint	10
Trip Point 1 Force Value	0
Trip Point 1 Direction	input below setpoint

In this example when this input's PV goes below 10 then the displayed value will be forced to ZERO. **IF** it cannot or does not go below 10 then the forced value will never happen.

**Trip Point 2 Setpoint, Trip Point 2 Force Value, and Trip Point 2 Direction** function identically to the above.

#### High Input Limit Setpoint

This is the high input limit setpoint. The range is **-32768.00 to 32768.00**.

#### High Input Limit Hysteresis

This is the high input limit hysteresis. The range is **-32768.00 to 32768.00**.

#### Factory Default configurations

	INPUT 1	INPUT 2	INPUT 3
Input Type	78.125 volts	4-20 mA	K
Filter Time	0	0	0
Initial Scale	0.00	-13.84	0
Full Scale	40.65	13.84	10000
Decimal Point Location	2	2	0

Open T/C	Up Scale	Up Scale	Up Scale
Input Offset	0.00	0.00	0
Trip Point 1 Setpoint	0.00	0.00	0
Trip Point 1 Force Value	0.00	0.00	0
Trip Point 1 Direction	Input above setpoint	Input above setpoint	Input above setpoint
Trip Point 2 Setpoint	0.00	0.00	0
Trip Point 2 Force Value	0.00	0.00	0
Trip Point 2 Direction	Input above setpoint	Input above setpoint	Input above setpoint
High Input Limit Setpoint	99.99	99.99	9999
High Input Limit Hysteresis	0.01	0.01	1

### Analog Output Setup

The 9210 Nitriding has the option of two analog outputs. The outputs are ranged for a 4 – 20 milliamp signal or a 0 – 20 milliamp signal. Each output comes with a factory default configuration dependent on the application. Each output can be modified prior to shipment to your facility or in the field by a supervisor.

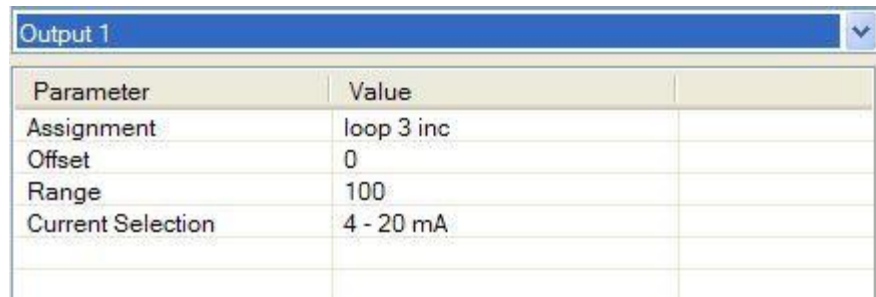

Parameter	Value
Assignment	loop 3 inc
Offset	0
Range	100
Current Selection	4 - 20 mA

### Analog Output Terminals

Analog output 1 – terminals 24 and 25  
 Analog output 2 – terminals 25 and 26

### Assignment

The analog output assignment can be modified depending on your system requirements. To change the Assignment first select which analog output you want to change by selecting it in the pull-down menu just below the main menu list. Clicking on this value will display an input box, and then you can use the pull-down menu to select the desired parameter. Once selected click **OK** and the displayed assignment under Value will be the current assignment type. The following is a list of the options:

- |              |                 |                   |
|--------------|-----------------|-------------------|
| PV 1 retrans | PV3 retrans     | Not Assigned      |
| Loop 1 inc   | Loop 3 inc      | SP1 retrans       |
| Loop 1 dec   | Loop 3 dec      | SP2 retrans       |
| Loop 1 combo | Loop 3 combo    | SP3 retrans       |
| PV 2 retrans | Input 1 retrans | Programmer ID Num |
| Loop 2 inc   | Input 2 retrans |                   |
| Loop 2 dec   | Input 3 retrans |                   |
| Loop 2 combo | Not Assigned    |                   |

### Offset

This is the starting point, the Process Variable value at which you get 4 milliamps. Clicking on this value will display an input box from which the user can select a new value. The range is **-32768 to 32767**.

### Range

This is a Process Variable value between 4 and 20 milliamps. Clicking on this value will display an input box from which the user can select a new value. The range is **-32768 to 32767**. *Note: The range, although not displayed with a decimal point, contains a decimal point that is dependent on the process variable selected.*

For example, if the offset is 20 mV for 4 mA, and you want 100 mV to be 20 mA, then your range should be 80. If the process variable is temperature, then the range will be 80, since temperature PVs do not have a decimal. If the PV is % Carbon, then the range will need to include the two decimal points for % Carbon. So, a range of 80 will be entered as 8000. See below for more examples.

### Current Selection

Provides the option of **4-20 mA** or **0-20 mA** control. Clicking on this value will display an input box with a drop-down list from which the user can select either of the two values listed above.

### Offset and Range when assigned to a control loop:

Inc -- 0 = 4mA, 100 = 20mA

Dec -- 0 = 4mA, -100 = 20mA

Example: if 4 - 20 mA = 800 mV - 1200 mV

Offset = 800 (starting point)

Range = 400

Example: if 4 - 20 mA = 800 mV - 1200 mV and PV is Temperature

Offset = 800 (starting point)

Range = 400

Example: if 4 - 20 mA = 800 mV - 1200 mV and PV is % Carbon

Offset = 800 (starting point)

Range = 40000 (400.00)

### Factory Default Configurations

	<u>Output 1</u>	<u>Output 2</u>
Assignment	Loop 3 Inc	Loop 2 Inc
Offset	0	0
Range	100	100
Current Selection	4 - 20 mA	4 - 20 mA

### Passcode and Alarm

There are four levels of menus in the 9210 Nitrider - Operator, Supervisor, Administrator, and SSi Special.

Parameter	Value
Level 1 Code	1
Level 2 Code	2
Web Level 1 Code	111
Web Level 2 Code	222
Web Change Enable	1
Programmer Alarm	normally open
Alarm 1	normally open
Alarm 2	normally open
Alarm 3	normally open

#### Operator Level

These are functions typically handled by a furnace operator and do not require a passcode. When an operator is logged in, the lock on the toolbar will be blue, .

#### Supervisor Level

These are functions typically used by a supervisor and require a level 1 passcode. When a supervisor is logged in, the lock on the toolbar will be gold, . To change the level 1

passcode, or the web level 1 passcode, click on the "Level 1 Code" value (range is **-32768** to **32767**) or the "Web Level 1 Code" value (range is **0** to **9999**) and an input box will be displayed where the user can select a new value.

### Administrator

These are functions typically used by an administrator and require a level 2 passcode. When an administrator is logged in, the lock on the toolbar will be green, . To change the level 2 passcode or the web level 2 passcode, click on the "Level 2 Code" value (range is **-32768** to **32767**) or the "Web Level 2 Code" value (range is **0** to **9999**) and an input box will be displayed where the user can select a new value.

### SSi Special

These are functions that cannot be accessed without a passcode provided by Super System Inc. These functions are vital to the operating modes of the controller and are typically never modified. When an SSi Special user is logged in, the lock on the toolbar will be red, .

### Web Change Enable:

Clicking on this value will toggle between a **1** and a **0**.

### Programmer Alarm

Also available in this menu option is the availability to change the status of the relay contact with relation to alarms. As shipped, the relay contact is open with no alarm. The user can choose either **normally open** or **normally closed**.

### Alarm 1

The user can choose either **normally open** or **normally closed**.

### Alarm 2

The user can choose either **normally open** or **normally closed**.

### Alarm 3

The user can choose either **normally open** or **normally closed**.

### IP Address

The IP Address menu item is a display of the current IP Address, IP Address Mask, and the IP Address Gateway of the 9210 Nitriding controller. Modification of the screen should not be done without contacting Super Systems Inc. This page allows the user to change the IP Address, IP Address Mask, and IP Address

Parameter	Value
IP Address	192.168.1.229
IP Mask	255.254.255.0
IP Gateway	192.168.1.1

Gateway. Clicking on any of the values will bring up an input box that will allow the user to edit the values. The range is **0** to **255** for all fields. *Note - If the IP address of the controller is changed, then the IP address*

*will have to be changed in the System Settings menu option (  ). Once the IP address has been changed, the communications will eventually be bad.*

### Event Control

Parameter	Value
Hold instrument number	0
Hold Minimum PV	0
Hold Maximum PV	2000
Event for Program Run	-1
Event for Program Reset	-1
Event 0	
Event 1	
Event 2	
Event 3	
Event 4	
Event 5	
Event 6	
Event 7	
Event 8	
Event 9	
Event 10	
Event 11	
Event 12	
Event 13	
Event 14	
Event 15	

The Event control provides the user manual control of actual event outputs. This is useful when testing wiring and field devices.

#### Hold Instrument Number

Clicking on this value will display an input box from which the user can select a new value. The range is **0** to **25**.

#### Hold Minimum PV

Clicking on this value will display an input box from which the user can select a new value. The range is **0** to **4000**.

#### Hold Maximum PV

Clicking on this value will display an input box from which the user can select a new value. The range is **0** to **4000**.

#### Event for Program Run

Clicking on this value will display an input box from which the user can select a new value. The range is **-1** to **15**.

#### Event for Program Reset

Clicking on this value will display an input box from which the user can select a new value. The range is **-1** to **15**.

#### Event 0 Through Event 15

The input box for these events has two drop-down lists. The top list contains **active** and **inactive**, and the bottom list contains **closed** and **open**.

#### Valve Configuration

This option will allow the user to configure the valve setup.

#### Control Mode

This option will set the control mode for the valve setup. The options are:

- Trim
- Flow
- Ratio
- Auto

Parameter	Value
Control Mode	individual trim
DA Switch Point	60
Auto Valve Event	no

#### DA Switch Point

This option will set the switch point for the disassociated ammonia for the valve setup. The range is **0** to **100**.

#### Auto Valve Event



This option will determine if there is an auto value event. The options are **Yes** or **No**.

### Valve Setup

Parameter	Value
Zero Scale	0
Full Scale	0
Trim Enable	no
Target Setpoint	0
Trim Range	0
Zero SP Scale	0
Full SP Scale	0
Valve Max	0
Deviation setpoint	Off
Dev. Alarm delay (sec)	18
Gas Type	Nitrogen
Valve Decimal Place	0

This option will allow the user to set up the valves for the 9210 Nitrider. There is a choice of four valves.

#### Zero Scale

The Zero Scale option will allow the user to set the zero scale for the valve. This value must be less than or equal to the **Valve Max** value.

#### Full Scale

This option will allow the user to set the full scale for the valve. This value must be less than or equal to the **Valve Max** value.

#### Trim Enable

This option will allow the user to set the trim enable option for the valve. The options are **Yes** or **No**.

#### Target Setpoint

The Target Setpoint option will allow the user to set the target setpoint for the valve. This value must be less than or equal to the **Valve Max** value.

#### Trim Range

This option will allow the user to set the trim range for the valve. This value must be less than or equal to the **Valve Max** value.

#### Zero SP Scale

This option will allow the user to set the zero scale for the setpoint. This value must be less than or equal to the **Valve Max** value.

#### Full SP Scale

This option will allow the user to set the full scale for the setpoint. This value must be less than or equal to the **Valve Max** value.

#### Valve Max

This option will allow the user to set the maximum flow rate for the valve. The range is **0** to **32767**.

#### Deviation Setpoint

This option will allow the user to set the deviation setpoint for the valve. The range is **0 (OFF)** to **32000**.

#### Deviation Alarm Delay (Seconds)

This option will allow the user to set the deviation alarm delay, listed in 1/10<sup>th</sup> of minutes. The range is **0** to **32000**. *Note: The alarm delay is entered in 1/10<sup>th</sup> of a minute intervals, but it is displayed in seconds, so 3/10 of a minute = 18 seconds.*

#### Gas Type

This option will determine the gas type for the valve.

### Valve Decimal Place

This option will set the decimal place for the valve. The range is 0 through 4.

### Standard Setup for Flow Alarms with Delays

The "Deviation Setpoint" is the flow alarm setpoint, and the "Dev. Alarm Delay (sec)" is the flow alarm delay time

	Valve 1	Valve 2	Valve 3	Valve 4
Zero Scale	0	0	0	0
Full Scale	300	300	150	0
Trim Enable	No	Yes	No	no
Target Setpoint	150	150	10	0
Trim Range	0	50	25	0
Zero SP Scale	0	0	0	0
Full SP Scale	300	300	150	0
Valve Max	300	300	150	0
Deviation Setpoint	20	60	10	Off
Dev. Alarm Delay (sec)	300	60	300	0
Gas Type	Nitrogen	Ammonia	Dissociated Ammonia	Hydrogen
Valve Decimal Place	0	0	0	0

### Set Menu Security

The Set Menu Security menu option is a feature that is used to limit access to certain menu options and parameters that are vital to successful operation and communication of your instrument. This page comes pre-configured by Super Systems Inc. and should not be adjusted without consulting SSI. The options are **operator**, **supervisor**, or **administrator**.

Parameter	Value
Program Edit	supervisor
CO Factor Entry	operator
Auxiliary Instruments	operator
Auxiliary Analog Input	operator
Shutdown	supervisor
Adjust Date and Time	supervisor
Slave Communications St...	supervisor
Backup Compressed Data	administrator
Manual Event Control	administrator
PID Loop Setup	administrator
Event Run Program Setup	administrator
Zone/Load TC Setup	administrator
Port Setup	administrator
Slave Instrument Setup	administrator
Zone Assignments	administrator
Furnace Setup	administrator
Default Wait Limits	administrator
Furnace Name	administrator
Alarm Setup	administrator
Relay Assignments	administrator
Relay Setpoints	administrator
Analog Input Setup	administrator
Output Setup	administrator
Passcodes and Alarm	administrator
IP Address	administrator
Event Control	administrator
Valve Setup	administrator
Valve Inputs	administrator
Programmer Setup	administrator

Curve 1	
Parameter	Value
Curve Type	none
Control Range	8683
mV 1	255
Vac 1	-11044
mV 2	-15336
Vac 2	4376
mV 3	24
Vac 3	19780
mV 4	24823
Vac 4	-5271
mV 5	6945
Vac 5	6404
mV 6	-6947
Vac 6	-11264
mV 7	-15342
Vac 7	4376
mV 8	24
Vac 8	19780
mV 9	24823
Vac 9	-5271
mV 10	6945
Vac 10	6404
mV 11	1553
Vac 11	6400
mV 12	-6947
Vac 12	-11264
mV 13	-15344
Vac 13	-5360
mV 14	33

**Curve Entry**

Curve Entry is typically used for Vacuum and Nitriding applications. It allows the user to enter custom flow curves and vacuum gauge curves for Curve 1 through Curve 5.

**Curve Type**

This is the type of curve. The options are **none** or **linear**.

**Control Range**

This is the control range for the curve. The range is **0** to **32000**.

**mV X(1 – 32)**

Clicking on this value will display an input box from which the user can select a

new millivolt value. The range is from **0** to **32000**.

### **Vac X(1 – 32)**

Clicking on this value will display an input box from which the user can select a new vacuum value. The range is from **0** to **32000**.

### Alternate PID Setup

The Alternate PID Setup menu option allows for up to 16 sets of PID values to be used on all three loops via the programmer.

This menu option is typically used for vacuum applications with the programmer.

There is a choice of PID 1 – 16, and LP1 Set 1 – LP3 Set 3.

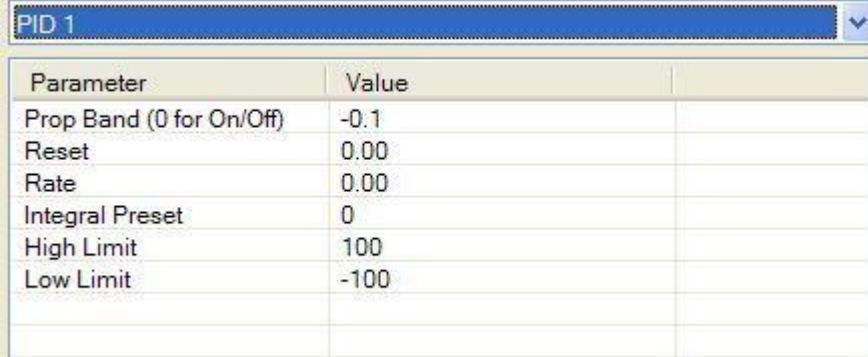

Parameter	Value
Prop Band (0 for On/Off)	-0.1
Reset	0.00
Rate	0.00
Integral Preset	0
High Limit	100
Low Limit	-100

### **Prop Band (0 for On/Off)**

This is the proportional band for the PID setup. P = Proportional (Prop Band). This is a field in which you want to stay around the setpoint. The range of values is **-1.0** to **999.0**.

### **Reset**

This is the reset value. I = Integral (Reset). This is the actual temperature being monitored over a period of time and then averaged to keep within the Proportional band. The reset is in repeats per minute. This affects the output of the controller. It will be proportional to the amount of time the error is present. This helps to eliminate offset. The range is **0.00** through **10.00**.

### **Rate**

This is the rate value. D = Derivative (Rate). This is the sudden change or rate in the temperature. This rate is in minutes. This affects the controller output which is proportional to the rate of change of the measurement and will control the amount of output by time restraints. Thus derivative takes action to inhibit more rapid changes of the measurement than proportional action. Derivative is often used to avoid overshoot. The range is **0.00** through **10.00**.

### **Integral Preset**

This is the integral preset value. This field provides an offset for the starting point for PID control, also referred to as "Load Line" or "Manual Reset". The range is **-100** to **100**.

### **High Limit**

This is the high limit value. The range is **-100** to **100**.

### **Low Limit**

This is the low limit value. The range is **-100** to **100**.

### SSi Analog Input Setup.

Module 1	
Parameter	Value
Input type 1	K
Input type 2	K
Input type 3	K
Input 1 Correction	not used
Input 2 Correction	not used
Input 3 Correction	not used

The SSi Analog Input Setup menu option allows the user an input selection of three inputs per module, as well as three input corrections per module. There are eight modules available. It is configurable for voltage of T/C (universal input), and it is typically used for Load T/Cs and Auxiliary Flow Meters.

### Input Type 1 – Input Type 3

Clicking on any of the values will display an input box from which the user can select the input type from a drop-down list with the following values:

B	NNM	160 mV	25.6 volts
C	R	80 mV	12.8 volts
E	S	40 mV	
J	T	20 mV	
K	2.56 volts	4-20 mA/124Ω	
N	1.28 volts	4-20 mA/62Ω	

### Input 1 Correction – Input 3 Correction

The corrections can either be **not used**, or **Curve 1 – Curve 3**. The curves are set up using the *TC Extension Correction Curves* menu option.

### SSi Configuration and Calibration

**\*\*\* Calibrate the inputs first, then perform a cold junction calibration \*\*\***

#### Overview

The series 9210 can be calibrated using the operator interface and Configurator software usually supplied with the system. Before performing this procedure on a newly installed controller, the unit needs to be powered on for at least 30 minutes for a warm up period.

The series 9210 has three analog inputs. Each range has a zero and span calibration value. A cold junction trim value must be calibrated for thermocouple inputs. There are two analog outputs each with a zero and span value.

#### Equipment needed

A certified calibrator(s) with the ability to input and read millivolts, milliamps and thermocouples is required. The appropriate connection leads are also required. A 24VDC 75-watt power supply is required. The operator interface method requires a PC with the Configurator software loaded. An Ethernet crossover cable is required.

#### Notes

- Input 1 – terminals 31 (-) and 32 (+)
- Input 2 – terminals 29 (-) and 30 (+)
- Input 3 – terminals 27 (-) and 28 (+)
- Output 1 – terminals 24 (-) and 25 (+)
- Output 2 – terminals 26 (-) and 25 (+)

## Calibrate Aux Analog Input

If an SSi analog input board is set up, then this menu option will be visible. For information on how to calibrate an SSi analog input board, see the *Appendix 4 – Calibration of SSi Analog Input Boards* section.

## User Calibration

Click on the “click” value next to the “User Calibration” field to start the user calibration. The *Calibration* screen will be displayed. **For complete calibration of Analog Inputs start with step #2 Zero and Span Calibration.**

The steps for calibration are:

1. Zero/Span the Inputs
2. Perform Cold Junction on the inputs
3. Zero/Span the Outputs

### Screen 2 - Zero then Span Calibration (Inputs and Outputs).

Clicking on the **Next ->** button will display the second screen (zero calibration) for the user calibration begin here for only calibrating the inputs terminals 27-32 (Analog Inputs). (cold junction will be completed as a final step)

In the “Zero Input 1/Range 2” section, verify that the Zero voltage that will be sourced is 0, and that the number box in the “Zero Input 1/Range 2” section shows 0.00. Click on the **Calibrate** button in the “Zero Input 1/Range 2” section. This will calibrate the zero range. While the input is being calibrated, the status bar will update itself with the progress.

In the “Span Input 1/Range 2” section, verify that the Span voltage that will be sourced is correct based on the suggested value or another value, and that the number box in the “Span Input 1/Range 2” section shows that value. Click on the **Calibrate** button in the “Span Input 1/Range 2” section. This will calibrate the span range. While the input is being calibrated, the status bar will update itself with the progress.

This process can be repeated for the next two screens – “Zero/Span Input 2/Range 0” and “Zero/Span Input 3/Range 2” – if necessary or desired.

Once the inputs have been calibrated, the user can return to screen 1 to perform the cold junction calibration.

### Screen 1 Cold Junction Calibration.

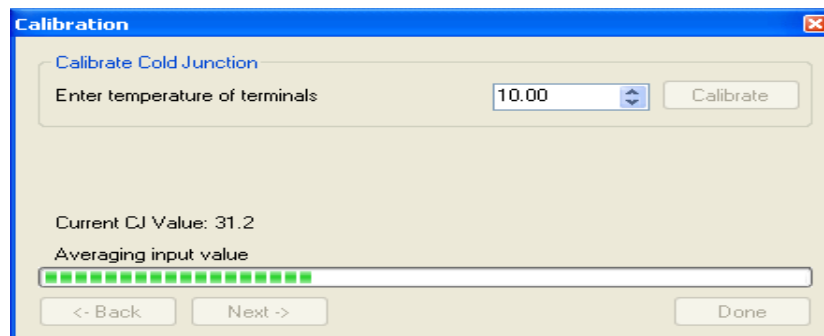

Using the appropriate T/C wire, measure the value of the desired input.

If adjusting the input by a preset amount for all temperature points please calibrate the cold junction by entering the current value of the selected input. Wait 120 seconds and verify with a source calibration

device with the correct T/C type. In the "Calibrate Cold Junction" section, enter the temperature of the terminals and click on the **Calibrate** button. This will calibrate the cold junction value. *Note: During a normal calibration procedure, the user should zero and span all of the inputs first and then perform a cold junction calibration, if necessary.*

The fifth screen in the user calibration will start calibrating the outputs. To calibrate the zero/span range for output 1, you must first attach your measuring device, then click on the **Prep for Zero** button. Let the unit output what it has set for the zero measurement, then enter what you are measuring coming out of the terminals in the input box for "Zero Output 1". *Note: The status bar will stop at "Averaging input value" and wait for user input before continuing – it will not finish.*

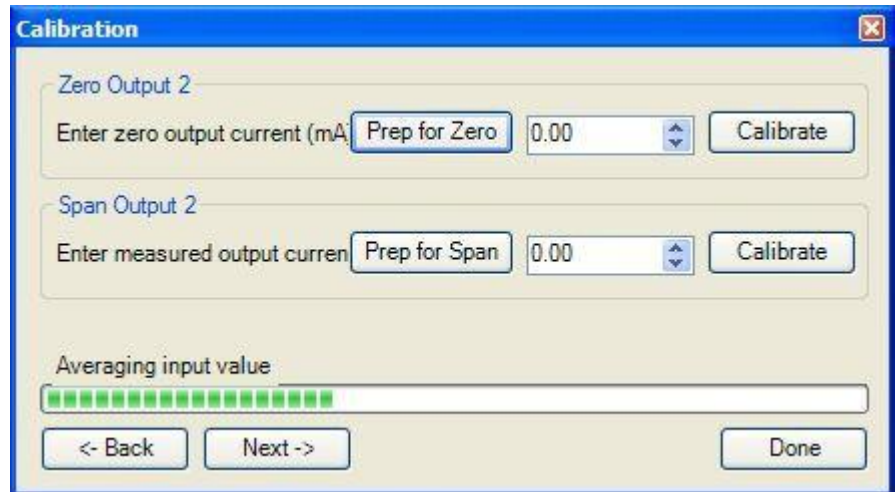

Once entered click on the **Calibrate** button and let the procedure finish. While the output is being calibrated, the status bar will update itself with the progress. Click on the **Prep for Span** button. Let the unit output what it has set for the span measurement, then enter what you are measuring coming out of the terminals in the input box for "Span Output 1". *Note: The status bar will stop at "Averaging input value" and wait for user input before continuing – it will not finish.* Once entered click on the **Calibrate** button and let the procedure finish. While the output is being calibrated, the status bar will update itself with the progress.

This process can be repeated for the next screen – "Zero/Span Output 2" – if necessary or desired.

## Full Calibration

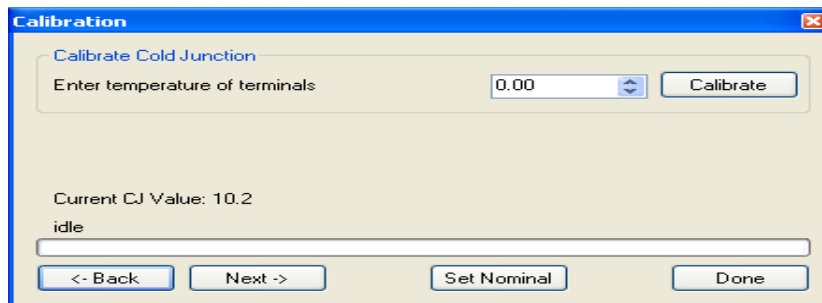

The *Calibration* screen for the Full Calibration menu option is identical in function and layout to the User Calibration's *Calibration* screen. The only difference is the Full Calibration's *Calibration* screen contains more screens. This list of screens is listed below in sequential order. Screens only found in the Full Calibration menu option are displayed in *Italics*. Screens only found in the User Calibration menu option are displayed in **bold**.

1. Cold Junction
2. *Zero/Span Input 0/Range 0*
3. *Zero/Span Input 0/Range 1*
4. *Zero/Span Input 0/Range 2*
5. *Zero/Span Input 0/Range 3*
6. *Zero/Span Input 1/Range 0*

7. Zero/Span Input 1/Range 1
8. Zero/Span Input 1/Range 2
9. Zero/Span Input 1/Range 3
10. Zero/Span Input 2/Range 0
11. Zero/Span Input 2/Range 1
12. Zero/Span Input 2/Range 2
13. Zero/Span Input 2/Range 3
- 14. Zero/Span Input 3/Range 2**
15. Zero/Span Input 1 Range Jumper
16. Zero/Span Input 2 Range Jumper
17. Zero/Span Input 3 Range Jumper
18. Zero/Span Output 1
19. Zero/Span Output 2
- 20.

The *Calibration* screen for the Full Calibration menu option also has a **Set Nominal** button, which will set nominal values for the current screen. The user will have to confirm the action.

Click the **Done** button to close the screen down.

#### ADAM Module Offset Correction

The ADAM Module Offset Correction menu option gives the user the ability to offset any input (1-40) on any ADAM.

#### **Enable Offsets for SSi AIB (Analog Input Board)**

This option will allow the user to enable offsets to be used for inputs on an SSi analog input board. The options are **Yes** or **No**.

#### **Input 1 – 40**

The offset can be in degrees + or -, and it is typically used to compensate for incorrect T/C wires. Clicking on any of the values will display an input box from which the user can select a new offset. The range is **-50.0** to **50.0**.

#### **Input 0 Correction – Input 39 Correction**

The user can also use a curve (set up in *Curve Entry* section) to apply as a correction to each of the

Parameter	Value
Enable offsets for SSi AIB	no
Input 1	0.0
Input 2	0.0
Input 3	0.0
Input 4	0.0
Input 5	0.0
Input 6	0.0
Input 7	0.0
Input 8	0.0
Input 9	0.0
Input 10	0.0
Input 11	0.0
Input 12	0.0
Input 13	0.0
Input 14	0.0
Input 15	0.0
Input 16	0.0
Input 17	0.0
Input 18	0.0
Input 19	0.0
Input 20	0.0
Input 21	0.0
Input 22	0.0
Input 23	0.0
Input 24	0.0
Input 25	0.0
Input 26	0.0
Input 27	0.0
Input 28	0.0



inputs. *Note: The inputs are labeled 1 to 40, but the input corrections are labeled 0 to 39, so Input Correction 0 is for Input 1, etc.*

Aux Setpoint Configuration

Parameter	Value
Retrans to Slave 1	Loop 1
Retrans to Slave 2	Off
Retrans to Slave 3	Off
Setpoint Offset SI 1	0
Setpoint Offset SI 2	0
Setpoint Offset SI 3	0
Setpoint Delay SI 1	0
Setpoint Delay SI 2	0
Setpoint Delay SI 3	0

See the menu option *Slave Instruments* for configuration prior to using *Aux Setpoint Configuration*. This menu option allows for up to 3 slave instruments to have the setpoint retransmitted from one of the three control loops. This menu option is typically used to retransmit an alarm setpoint value to an overtemp controller.

measured in seconds.

The Setpoint Offset Delays are

Clicking on the values for "Retrans To Slave 1", "Retrans to Slave 2", or "Retrans to Slave 3" will display an input box with a drop-down list from which the user can select the new value. The options are

- Off
- Loop 1
- Loop 2
- Loop 3

Clicking on any of the values for "Setpoint Offset SI 1", "Setpoint Offset SI 2", "Setpoint Offset SI 3", "Setpoint Delay SI 1", "Setpoint Delay SI 2", or "Setpoint Delay SI 3" will display an input box from which the user can select the new value. The range is **-32768** to **32767**.

TC Extension Correction Curves

This menu option will allow the user to set up to three TC

Parameter	Value
1	click
2	click
3	click

correction curves for the 9210 Nitrider. Clicking on the "click" value for a curve will display the curve edit form. *Note: If the first "Temperature" value and the first "Error" value are both zero, then the curve will not be set.* The user can enter up to ten "Temperature"/"Error" combinations. The range for the "Temperature" field is **-300** to **9999**. The range for the "Error" field is **-30.000** to **30.000**.

### Tuning Assistant

The tuning assistant will allow the user to automatically generate the PID settings for a specific loop. Click on the “click” value to start the tuning assistant.

Parameter	Value
Tuning Assistant	click

The user can select the loop to auto tune from the drop-down list next to the “Loop” label. The choices are: **Loop 1**, **Loop 2**, or **Loop 3**. The type of tuning to be used can be selected from the “Tuning Type” section in

The screenshot shows the 'Tuning Assistant' dialog box. It features a 'Tuning Type' section with radio buttons for 'Relay' and 'Limited Relay', where 'Limited Relay' is selected. A 'Loop' dropdown menu is set to 'Loop 2'. There is a 'Conservative' checkbox which is currently unchecked. The 'Tuning Delta' is set to 65, with an 'Edit' button next to it. The current process variable (PV) is 1688 and the setpoint (SP) is 1700. Below this, there is an 'Idle' label and a table with four empty columns. At the bottom, there are several buttons: 'Accept Under Damped', 'Accept Critically Damped', 'Accept Over Damped', 'Accept PI', 'Start', 'Abort', 'Edit', and 'Done'.

the top left of the form. The options are either **Relay** or **Limited Relay**. Using the **Relay** option will just use 100% output while the 9210 Nitrider is controlling the furnace. The **Limited Relay** option will reduce the % output by a user-specified amount. When the **Limited Relay** option is selected, the “Tuning Delta:” label and the **Edit** button will be visible. When the **Relay** option is selected, these two items will be invisible. Clicking on the **Edit** button will allow the user to select the new % output value. The “Conservative” option will allow the user to minimize, if not remove, the possibility for an

overshoot of the setpoint. If a small overshoot is acceptable, leave the “Conservative” checkbox unchecked. If, however, no overshoot is desired, then checking the “Conservative” checkbox will accomplish this. The current value for the process variable (PV) and the selected loop’s setpoint (SP) will be displayed under the “Tuning Types” section. Click on the **Start** button to begin the auto tune process. *Note: The process may take a few seconds to start.* Once the process has started, the “Idle” line will change to “Tuning: Pointer xx”. This means that the tuning process is working. When the tuning is finished, the “Tuning: Pointer xx” line will read “Idle” again, and the list underneath will be populated with suggested PID settings. *Note: clicking on the **Done** button while the tuning is in progress will close down the screen, but the user will have to confirm the action. However, clicking on the **Abort** button will simply abort the calibration process.*

Each column for the PID settings relates to the button below. For example, the second column is the PID settings for the Critically Damped values. The user can accept only one set of numbers. To select a set of values, click on the corresponding button. For example, to accept the critically damped values, click on the **Accept Critically Damped** button.

The under damped values will reach the setpoint faster, but there will be more overshoot involved. The over damped values will work to minimize the overshoot, but it will be slower than the under damped values. The critically

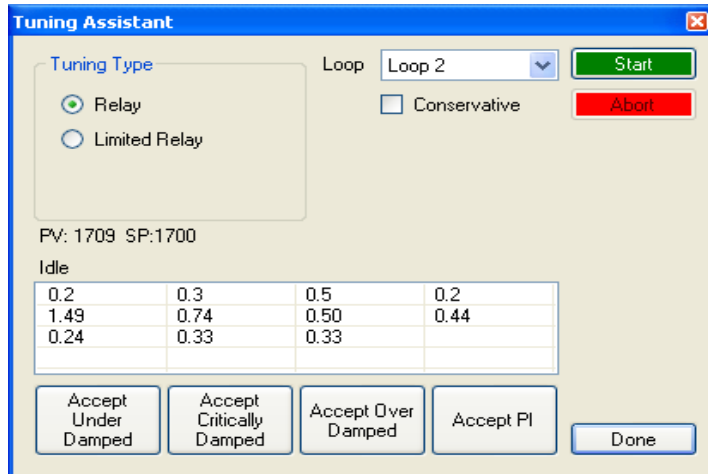

damped values are considered the “optimum” values because they are a balance between the under damped and over damped values with regards to time and overshoot. The PI values are just the proportional band and the reset value (the *P* and the *I* from *PID*). This could be applicable in an atmosphere loop, where the rate won’t have much effect.

Once a set of values has been accepted, the user can press the **Done** button to exit the screen. The accepted values can be viewed on the *PID Loop Setup* menu option. *Note: Once the screen is closed out, the PID settings values will be lost.* To populate these values again, another tuning routine will need to be run.

#### DF1 Configuration

This section will allow the user to set up the DF1 configuration settings.

Parameter	Value
My node	6
PLC node	1
PLC read table	13
PLC write table	12
PLC intermessage delay (ms)	0

#### My Node

This option will allow the user to select the node. This node must not exist anywhere else on the computer’s network. The range is 0 to 30000.

#### PLC node

This option will allow the user to select the PLC node. This must be

the node address of a PLC. The range is 0 to 30000.

#### PLC read table

This option will allow the user to select the PLC read table. The range is 8 to 255.

#### PLC write table

This option will allow the user to select the PLC write table. The range is 8 to 255.

#### PLC Intermessage Delay

This option will allow the user to set the delay, in milliseconds. The range is 50 to 5000.

## Chapter 5 - PROGRAMS

### Overview

The program format used in the SERIES 9210 provides a simple but powerful recipe language for controlling the heat-treat process. The SERIES 9210 can store up to 300 programs of twenty-four steps each. Each step consists of an opcode that defines what is done at this step. The step can also contain atmosphere, temperature, and option data.

This enhanced step approach provides for shorter programs. For example, a complete boost /diffuse program can be done in twenty-four steps.

The programmer also has alarm capability that can be turned on during a program to monitor deviations and high and low limits while the program is running.

### Program Editing

The program edit display is accessed through the **Menu** key on the default display screen. Pressing the **Menu** key displays a screen that contains the configuration items that the operator is allowed to perform. On that screen, running down the right side are five buttons. Below the blue down arrow key is the **Login** key. Pressing this key displays a numeric keypad that allows you to enter the

Step	Opcode	Temp	Atm	Option
1	GOSUB			50
2	GOSUB			51
3	VALVE_SET	100	20	Ammonia
4	SETPT		12.0	
5	SOAK			2:00
6	VALVE_SET	50	25	Ammonia
7	SETPT		25.0	
8	SOAK			8:00
9	EVT_OUT			3 -ON
10	VALVE_SET	100		Nitrogen
11	VALVE_SET	0		Ammonia
12	JUMP			60

passcode to get to the configuration level (default as shipped from SSI is the number 1). Pressing the number 1 and then pressing the **Enter** button displays the many configuration menu options, the first option is *Program Edit*. Highlighting this parameter and pressing the **Enter** key displays a numeric keypad that asks you to enter the number of the program that you wish to edit. Pressing that recipe number and then pressing **Enter** displays that particular recipe. You may have to clear the recipe number that is shown in the display box if the number of the recipe to be edited was not the last recipe run on the system. Press the **Clr** button on the numeric keypad and then enter the number for the recipe that you wish to edit.

To edit a step in the recipe, use the up and down arrow keys to highlight the step that you wish to edit and press the **Enter** key. This will display the

Step Edit screen.

Highlighting the parameter that you wish to edit and pressing the **Enter** key takes you to the appropriate menu - either that of the Opcode choices, or a numeric keypad to allow you to change the value.

Parameter	Value	↑	↓	Enter	Set	Cancel
Opcode	SOAK	↑	↓	Enter	Set	Cancel
Time (hh:mm)	1:00	↑	↓	Enter	Set	Cancel
Soak Step						
Parameter	Value	↑	↓	Enter	Set	Cancel
Opcode	EVT_OUT	↑	↓	Enter	Set	Cancel
Temperature Setpoint	1800	↑	↓	Enter	Set	Cancel
Atmosphere Setpoint	20.50	↑	↓	Enter	Set	Cancel
Event Number	1-ON	↑	↓	Enter	Set	Cancel
Event Output Step						

*Note: See Chapter 5 – SERIES 9210 Opcodes for a list of the opcodes.*

After making the change, press the **Set** button to keep the change, or press the **Cancel** button to cancel the change. This returns you to the *Program Edit* menu screen. The **Insert** button will allow the user to insert a step into the recipe. The **Delete** button will delete a step from the recipe. The **Save** button will display a numeric keypad that will allow the user to save the recipe, either with the original recipe number, or with a new recipe number. This is a quick way to make new recipes using an already existing recipe and changing only those steps that need to be changed. The Esc button will return the user to the *Configuration* menu.

## Chapter 6 - SERIES 9210 Opcodes

---

### Programmer Description

The SERIES 9210 series Atmosphere/Temperature Recipe Programmer provides a convenient operator interface and recipe programmer.

The programmer uses enhanced Opcodes that reduce the number of steps required for a program. Each step consists of an opcode, an optional temperature value, an optional atmosphere value, and an option value. The opcode determines how and if each of the three values are used.

### Opcodes

*NO-OP* This no operation code does nothing and is used as a place hold on programs that are less than 24 steps.

*ALARM* This alarm function is used to notify the operator that an operation is complete or that a manual action is required. The program waits until the alarm is acknowledged to proceed. The option is the alarm number to display.

*ATM\_INQ* The atmosphere inquiry is used to wait for the actual atmosphere to reach the specified atmosphere setpoint.

The options are:

- wait, reach within band;
- wait up, reach or exceed the setpoint;
- wait down, reach or be less than the setpoint.

The default band can be set under the *Configuration* menu and is typically 10 (i.e. 0.10 percent dissociation).

- The *SET\_WAIT* opcode will change the band limit

The *LIMIT* opcode immediately following this opcode sets a time limit on the wait.

A *BRANCH* opcode immediately following this opcode can be used to change the program flow based on the inquiry results.

*BO\_start* the Burnoff Start opcode will start a burnoff on the controller. The options are:

- Start
- Start + wait
- Check + wait

*BRANCH* The *BRANCH* opcode can change program flow based upon an inquiry opcode. The temperature data is interpreted as the program step if the inquiry is true and the atmosphere data as the program step if the inquiry is false.

*CC\_SP\_L* The *Cascade Setpoint Limit* opcode will allow the user to set the upper and lower limits for the cascade setpoint. The temperature data is the lower limit, and the atmosphere data is the upper limit.

*DELAY* This opcode is used when a short delay is needed. The option value is the delay time in seconds.

*DEV\_AL* This deviation alarm opcode is used to turn the temperature or atmosphere deviation alarms ON or OFF.

The option values are:

- OFF, turns OFF both the temperature and atmosphere alarms
- TEMPERATURE, turns ON the temperature alarm and turns OFF the atmosphere alarm
- ATMOSPHERE, turns ON the atmosphere alarm and turns OFF the temperature alarm
- BOTH, turns ON both the temperature and the atmosphere alarms.

The band limit can be changed by the *SET\_WAIT* opcode.

*DOW\_INQ* This opcode checks the real time clock for the day of the week. This is useful for performing operations on a weekly basis on a specific day. The option data is the day of the week, i.e. SUN, MON, TUE, WED, THU, FRI, and SAT.

*EVT\_IN* This opcode waits for an input event to be turned ON or OFF depending on the option value. The option value is the event number followed by either ON or OFF.

If temperature data and or atmosphere data are specified, they are considered setpoints and will be sent to the appropriate controller.

*EVT\_OUT* The *Event Output* opcode turns an output ON or OFF event based upon the option value. The option value is the event number followed by either ON or OFF.

If temperature data and or atmosphere data are specified, they are considered setpoints and will be sent to the appropriate controller.

*G\_SOAK* This is a guaranteed soak opcode. The temperature process value must be within the deviation band to allow the soak timer to run. The option value is the soak time in hours and minutes. The band limit can be changed by the *SET\_WAIT* opcode. If Load TC Enable is set to ON, this opcode will wait for all temperature inputs selected to be within the deviation band before starting the soak timer.

*GDELAY* This is the guaranteed delay opcode. This opcode is used when a short delay is needed. The option value is the delay time in seconds. This opcode will only countdown when the temperature process value is in band.

*GHDELAY* This is a guaranteed high delay opcode. The temperature process value must be within the setpoint and the high deviation band range to allow the timer to run. The option value is the delay time in seconds.

*GHSOAK* This is a guaranteed High soak opcode. The temperature process value must be within the setpoint and the high deviation band range to allow the soak timer to run. The option value is the soak time in hours and minutes. The band limit can be changed by the *SET\_WAIT* opcode. If Load TC Enable is set to ON, this opcode will wait for all temperature inputs selected to be within the acceptable band before starting the soak timer.

*GHZDELAY* This is a *Guaranteed Delay High* opcode for a zone. The temperature process value must be above the deviation band to allow the soak timer to run. The option value is the delay time in seconds. The band limit can be changed by the *SET\_WAIT* opcode.

*GHZSOAK* This is a *Guaranteed Soak High* opcode for a zone. The temperature process value must be above the deviation band to allow the soak timer to run. The option value is the soak time in hours and minutes. The band limit can be changed by the *SET\_WAIT* opcode.

*GLDELAY* This is a guaranteed Low delay opcode. The temperature process value must be within the setpoint and the low deviation band range to allow the soak timer to run. The option value is the delay time in seconds. The band limit can be changed by the *SET\_WAIT* opcode. If Load TC Enable is set to ON, this opcode will wait for all temperature inputs selected to be within the acceptable band before starting the delay timer.

*GLSOAK* This is a guaranteed Low soak opcode. The temperature process value must be within the setpoint and the low deviation band range to allow the soak timer to run. The option value is the soak time in hours and minutes. The band limit can be changed by the *SET\_WAIT* opcode. If Load TC Enable is set to ON, this opcode will wait for all temperature inputs selected to be within the acceptable band before starting the soak timer.

*GLZDELAY* This is a *Guaranteed Delay Low* opcode for a zone. The temperature process value must be below the deviation band to allow the delay timer to run. The option value is the soak time in seconds. The band limit can be changed by the *SET\_WAIT* opcode.

*GLZSOAK* This is a *Guaranteed Soak Low* opcode for a zone. The temperature process value must be below the deviation band to allow the soak timer to run. The option value is the soak time in hours and minutes. The band limit can be changed by the *SET\_WAIT* opcode.

*GOSUB* The go to subroutine (recipe) opcode is used to call a program and then return to the calling program. This is used to execute standard routines that can be used by many programs. *GOSUBs* can be stacked up to eight levels. The option data is the program number.

*GRAMP* This opcode changes the temperature setpoint and/or the atmosphere setpoint linearly over time. The option data is the total ramp time in hours and minutes. The temperature data specifies the final setpoint for the temperature setpoint. The atmosphere data specifies the final value for the atmosphere setpoint. This opcode will cause the setpoint change to wait until all temperature values are within the deviation limit band. If the temperature falls outside of the band, the ramp will wait until the temperature is within the band.

*GTCINQDEL* This is a *Guaranteed Temperature Inquiry Delay* opcode. The process value must be within the deviation band to allow the inquiry. The temperature data is the delay time in seconds, the atmosphere data is the T/C to check, and the option data is:

- Wait
- Wait up
- Wait Down

*GZ\_SOAK* This is a *Guaranteed Soak* opcode for a zone. The temperature process value must be within the deviation band to allow the soak timer to run. The option value is the soak time in hours and minutes. The band limit can be changed by the *SET\_WAIT* opcode.

*GZDELAY* This is a *Guaranteed Dealy* opcode for a zone. The temperature process value must be within the deviation band to allow the Delay timer to run. The option value is the delay time in seconds. The band limit can be changed by the *SET\_WAIT* opcode.

*GZRAMP* This is a *Guaranteed Ramp* opcode for a zone. The process value must be within the deviation band to allow the ramp timer to run. The temperature data is the temperature set point, the atmosphere data is the atmosphere setpoint, and the option data is the ramp time in hours and minutes. The band limit can be changed by the *SET\_WAIT* opcode.



*HIGH\_AL* This opcode is used to enable a high limit alarm on the temperature process and/or the atmosphere process. The temperature data is the high limit point for the temperature process. The atmosphere data is the high limit point for the atmosphere process. This alarm remains active until the program ends.

*HIGH\_PO* This opcode is used to enable a high limit alarm on the temperature percent output and/or the atmosphere percent output. The temperature data is the high limit point for the temperature percent output. The atmosphere data is the high limit point for the atmosphere percent output. This alarm remains active until the program ends.

*ID\_INC* This opcode increments the ID number by one. No data is required.

*ID\_INQ* This opcode is used to compare the ID value to the value in the temperature data. The option data is equal, high, or low. The *LIMIT* opcode immediately following this opcode sets a time limit on the wait. A *BRANCH* opcode immediately following this opcode can be used to change the program flow based on the inquiry results.

*ID\_SET* This opcode is used to set the ID number to the value specified in the temperature data. The atmosphere and option data are not used. The ID number is provided as a feature to track loads or jobs and is not used by any controller.

*IN\_inq* The *Input Inquiry* opcode will allow the user to check one of the inputs for a specific value. The temperature data is the value to check for. The atmosphere data is the input to check. The options are wait, wait up, or wait down. The *LIMIT* opcode immediately following this opcode sets a time limit on the wait. A *BRANCH* opcode immediately following this opcode can be used to change the program flow based on the inquiry results.

*JUMP* The *JUMP* opcode is used to go to another program when no return is needed. The option data is the program number to execute next. This differs from the *GOSUB* opcode in that the *JUMP* will not return to the calling recipe when the next recipe has finished.

*LIMIT* This option is used to place a time limit on a wait or inquiry step. The option data is the time limit to wait in hours and minutes. Should the time run out before the wait or inquiry is satisfied an alarm occurs.

*LOW\_AL* This opcode is used to enable a low limit alarm on the temperature process and/or the atmosphere process. The temperature data is the low limit point for the temperature process. The atmosphere data is the low limit point for the atmosphere process. This alarm remains active until the program ends.

*LOW\_PO* This opcode is used to enable a low limit alarm on the temperature percent output and/or the atmosphere percent output. The temperature data is the low limit point for the temperature percent output. The atmosphere data is the low limit point for the atmosphere percent output. This alarm remains active until the program ends.

*MV\_INQ* The millivolt inquiry is used to wait for the probe millivolts to reach the value specified in the atmosphere data.

The options are:

- wait, reach within band;
- wait up, reach or exceed the value;
- or wait down, reach or be less than the value.

The *LIMIT* opcode immediately following this opcode sets a time limit on the wait.  
A *BRANCH* opcode immediately following this opcode can be used to change the program flow based on the inquiry results.

*PIDLOAD* This opcode is used to assign a different set of PID parameters to Loop 1, Loop 2 or Loop 3. The temperature data is the Alternate PID set to be used for Loop 2. The atmosphere data is the Alternate PID set to be used for Loop 1. The option data is the Alternate PID set to be used for Loop 3. The PID parameters selected remain active until the recipe selects a different set of PID parameters to use. Setting a value of -1 for each loop will cause the 9210 to use the PID Setup parameters listed under the PID Setup Menu.

*PLC\_SET\_VAL* This opcode is used to assign a specific value to a PLC. The temperature data is the value to be sent. The atmosphere data is the write location in the PLC. The locations for the writes can be set up in the PLCConfig.ssiocf file. The option data is:

- Nothing
- Wait
- Wait up
- Wait down

*PO\_INQ* The percent output inquiry is used to test the actual percent output of the temperature and/or atmosphere controller.

The options are:

- wait, reach within band;
- wait up, reach or exceed the specified value;
- or wait down, reach or be less than the specified value.

The *LIMIT* opcode immediately following this opcode sets a time limit on the wait.  
A *BRANCH* opcode immediately following this opcode can be used to change the program flow based on the inquiry results.

*QTCSET* This is the *Quench Instrument Setpoint* opcode. This will allow the user to set the setpoint for a quench cycle. The temperature data is the temperature setpoint.

*QUENCH* The *QUENCH* opcode is used to start a quench cycle. The quench cycle is independent of any program that is running. The temperature data is the quench temperature controller set point. The atmosphere data is the quench time in minutes. The option data can be used to control the agitator speed, high or low, by event #6. Event #6 OFF equals low speed, and Event #6 ON equals high speed. The quench temperature controller must be *Aux Instrument # 4*. The quench cycle starts when the opcode is executed. The setpoint is sent to the quench temperature controller, the timer is started, and the high-speed event is turned on if it is selected. When the quench timer times out, the end of quench cycle (event #7) is turned on for one second and the high speed event is turned off.

**NOTE: Not used with Nitriding Application**

*RAMP* This opcode changes the temperature setpoint and/or the atmosphere setpoint linearly over time. The option data is the total ramp time in hours and minutes. The temperature data specifies the final setpoint for the temperature setpoint. The atmosphere data specifies the final value for the atmosphere setpoint.

*RAMPR* This opcode changes the temperature setpoint at the rate specified in deg/min. The option data is the ramp rate in degrees/minute. The temperature data specifies the final setpoint for the temperature setpoint.

*RESET* This opcode is used to clear all stacks and timers and starts a program. The temperature data is interpreted as a program number and the atmosphere data as a program step. The option data is not used. The RESET is useful in a weekend shut down program to restart the normal operating program.

*RAMPR AUX* This opcode changes the temperature setpoint at the rate specified in deg/min for an auxiliary instrument. The temperature data specifies the final setpoint for the temperature setpoint. The atmosphere data is the auxiliary instrument to use. The option data is the ramp rate in degrees/minute.

*SET\_AUX* The *Set Auxiliary Instrument Setpoint* opcode is used with other instruments in the process such as flow control or belt speed. The temperature data is the setpoint and the option data is the instrument number.

*SET\_BP* This opcode is used to set the backpressure set point. The atmosphere data is the atmosphere setpoint. The options are None, Wait up & Wait down

*SET\_FACT* This opcode is used to set the CO factor or the H2 factor of the atmosphere controller. If the atmosphere type for the loop is set to dew point then the H2 factor is set; otherwise the CO factor is set.  
The temperature data is not used.  
The atmosphere data is used as the factor with decimal places ignored.  
The option data is wait, wait up, or wait down. This allows the control loop to recover from the change before continuing the program.

*SET\_FCM* This opcode sets the gas flow control mode. There are four options: Individual trim, Flow control adjusts two valves, Ratio control – Maintains constant ratio between NH3 +, Auto switch – Switches between Options 1 & 2 based on the DA switch point.

- **Individual Trim will adjust the Gas flow of a valve if Trim is enabled.**
- **Flow Control adjusts the flows of all enabled valves by the same percentage.**
- **Ratio Control maintains a constant total flow of gas into the furnace by adjusting only the Ammonia and Dissociated Ammonia flows. This does not apply to the Nitrogen or Aux Valves.**

*SET\_LP3* This opcode is used to set a value to loop 3.  
The temperature data is the setpoint to assign.

*SET\_SL\_VAL* This opcode is used to set a value on a slave instrument.  
The temperature data is the value to set.  
The atmosphere data is the register of the slave instrument.  
The option data is the slave instrument number.

*SET\_VALVE* This opcode is used to set a value to a valve.  
The temperature data is the value to send.  
The atmosphere data is the trim range.  
The option data is the valve to use. The options are: Nitrogen, Ammonia, D.A., or Endo.

*SET\_WAIT* This opcode sets the band limits for the wait option or inquiry opcodes. The temperature data specifies the temperature band ( i.e. +/- the value) and the atmosphere data specifies the atmosphere band.

*SETPT* This opcode is used to set the temperature and/or atmosphere setpoints. Either or both of the setpoints can be specified. The options are None, Wait up or Wait down. If both setpoints are specified the Wait applies to both.

*SL\_PV\_INQ* This opcode will make an inquiry on a process variable on a slave instrument. The temperature data is the process variable value to check. The atmosphere data is the slave instrument number. The options are: Wait, Wait up, or Wait down.

*SOAK* This opcode is an unconditional soak for the time (in hours and minutes) specified in the option data.

*TC\_CHK* The temperature check will check up to three sources – instruments or process variable loops. The temperature data is source 1; the atmosphere data is source 2; the option data is source 3.

*TC\_INQ* The temperature inquiry is used to wait for the actual control temperature to reach the specified temperature setpoint.

The options are:

- wait, reach within band;
- wait up, reach or exceed the setpoint;
- or wait down, reach or be less than the setpoint.

The default band can be set under the configuration menu and is typically 15degrees. The band limit can be changed by the *SET\_WAIT*opcode.

The *LIMIT*opcode immediately following this opcode sets a time limit on the wait.

A *BRANCH*opcode immediately following this opcode can be used to change the program flow based on the inquiry results.

*TimeEVT* This opcode will allow the user to add in a delay before turning an event on or off. The atmosphere data is the delay time in seconds. The options are the events.

*TOD\_INQ* This opcode is a time of day inquiry which would be used to start a process or subroutine at a specific hour and minute. The option data is entered in the 24 hour format (i.e. 2:30pm is 14:30).

*TZ\_INQ* The zone temperature inquiry is used to wait for the actual control zone temperature to reach the value specified in the Temperature data.

The options are:

- wait, reach within band
- wait up, reach or exceed the set point
- wait down, reach or be less than the set point

The default band can be set under the *Configuration* Menu and is typically 15 degrees. The band limit can be changed by the *SET\_WAIT*opcode.

The *LIMIT*opcode immediately following this opcode sets a time limit on the wait. A *BRANCH* opcode immediately following this opcode can be used to change the program flow based on the inquiry results.

*VLUP\_chk* This opcode will perform a vacuum leak-up check and go to a specific step in the recipe depending on whether the check passes or fails. The temperature data is the step to go to if the check passes. The atmosphere data is the step to go to if a retry is needed. The option data is the step to go to if the check fails.

*Z\_SETPT*This opcode is used to set the temperature and/or atmosphere set points for a zone. Either or both of the set points can be specified. The options are None, Wait, Wait Up, or Wait Down. If both set points are specified, the Wait applies to both.

*ZONE\_OFF* The *Zone Offset* opcode is used to set an offset to be added to the set point sent to a specific zone. Either temperature, atmosphere, or both can be offset. The same loop (furnace) can have different offsets for each zone. The zones must be defined in the zone configuration.

For example, a pit furnace has three zones: top, middle, and bottom.  
The zones could be defined as:

- top = zone 1,
- middle = zone 2 ,
- bottom = zone 3.

If the *ZONE\_OFF* opcode is used in a program with temperature data = 50 and zone = 1, then a temperature set point value in the following steps of 1700 would be sent to the middle and bottom as 1700 and the top as 1750.

## Chapter 7 - APPLICATIONS INFORMATION

---

### Standard Event Assignments

To simplify operation and maintain consistency, SSI has adopted the following event assignments.

Event 0	Nitrogen Addition
Event 1	Ammonia Addition
Event 2	Disassociated Ammonia Addition
Event 3	Hydrogen Addition
Event 4	Spare
Event 5	Spare
Event 6	Spare
Event 7	Sample Cell Enable
Event 8	Spare
Event 9	Spare
Event 10	Spare
Event 11	Spare
Event 12	Spare
Event 13	Spare
Event 14	Spare
Event 15	Spare

### **Typical Nitriding Instrument Designations**

Instrument 7 – Nitrogen

Instrument 8 – Ammonia

Instrument 9 – Disassociated Ammonia

### Nitriding Recipes/Programs

Nitriding Recipes can be broken down into three stages, Startup, Nitriding and Shutdown

In the Startup phase of the recipe, the furnace starts to heat up and is purged with Nitrogen. As a general rule to assure safe operation of the furnace, the furnace should be purged with Nitrogen long enough to allow for 5 to 7 volume changes. This ensures that it will be safe to add Ammonia and/or Dissociated Ammonia when required. This purge time is determined by calculating the furnaces volume and dividing by the Nitrogen Flow. The startup phase can also start adding ammonia once the desired purge time and temperature has been achieved.

In the Nitriding process stage of the recipe, the temperature and %Dissociation/Kn setpoints are set and the Soak times are set as well. This phase will also enable the Trim enable feature for ammonia to allow for control of the furnace atmosphere to setpoint.

After the Nitriding process stage, the shutdown routine will run. This typically involves, shutting off the Ammonia and Dissociated Ammonia, turning on Nitrogen and lowering the temperature setpoint to allow the furnace to cool. This stage will also sound an alarm indicating the process is complete.

### SAMPLE RECIPES

#### **Recipe 1 – Nitrider Program**

Step #	Opcode	Description			Option	Comment
1	GOSUB	Goto subroutine			251	

2	SET_VALVE	Set valve setpoints	150	0	Ammonia	
3	SET_VALVE	Set valve setpoints	0		Nitrogen	
4	TC_INQ	Temperature inquiry	975 °F	0	Wait	
5	SETPT	Set point		20.00%		
6	SOAK	Soak			1:30	
7	ALARM	User alarm			User alarm 4	
8	TC_INQ	Temperature inquiry	975 °F		Wait	
9	SETPT	Set point		25.00%		
10	SET_VALVE	Set valve setpoints	150	90	Ammonia	
11	G_SOAK	Guaranteed soak (temperature)			3:00	
12	SETPT	Set point	975 °F	75.00%		
13	SET_VALVE	Set valve setpoints	50	35	Ammonia	
14	SET_VALVE	Set valve setpoints	100		Nitrogen	
15	G_SOAK	Guaranteed soak (temperature)			3:00	
16	SETPT	Set point	975 °F	90.00%		
17	SET_VALVE	Set valve setpoints	37	0	Ammonia	
18	G_SOAK	Guaranteed soak (temperature)			3:00	
19	SETPT	Set point	100 °F	0.00%		
20	TC_INQ	Temperature inquiry	500 °F		Wait	
21	SET_VALVE	Set valve setpoints	0	0	Ammonia	
22	TC_INQ	Temperature inquiry	250 °F		Wait	
23	GOSUB	Goto subroutine			260	
24	NO-OP	No opcode				

**Recipe 251 – Preheat, Purge, and O2 Check**

Step #	Opcode	Description			Option	Comment
1	SETPT	Set point	975 °F	0.00 %		
2	SET_BP	Set backpressure	10.00			Set back pressure
3	SET_VALVE	Set valve setpoints	150		Nitrogen	Set N2 purge
4	SET_VALVE	Set valve setpoints	0	0	Ammonia	Verify NH3 Off
5	SET_VALVE	Set valve setpoints	0	0	Disociated Ammonia	Verify DA Gas Off
6	EVT_OUT	Event output			6-OFF	
7	EVT_OUT	Event output			7-OFF	
8	SOAK	Soak			0:45	Purge N2
9	EVT_OUT	Event output			7-ON	Sample on for O2 Check
10	EVT_IN	Wait for event input			5-ON	Verify below 1% O2
11	LIMIT	Time limit on wait			0:30	Wait 30 Min and Alarm if above 1%
12	NO-OP	No opcode				
13	NO-OP	No opcode				
14	NO-OP	No opcode				
15	NO-OP	No opcode				
16	NO-OP	No opcode				

17	NO-OP	No opcode				
18	NO-OP	No opcode				
19	NO-OP	No opcode				
20	NO-OP	No opcode				
21	NO-OP	No opcode				
22	NO-OP	No opcode				
23	NO-OP	No opcode				
24	NO-OP	No opcode				

**Recipe 260 – End of Cycle**

Step #	Opcode	Description			Option	Comment
1	SETPT	Set point	0 °F	0.00%		
2	SET_VALVE	Set valve setpoints	0	0	Nitrogen	
3	SET_VALVE	Set valve setpoints	0	0	Ammonia	
4	SET_VALVE	Set valve setpoints	0	0	Disociated Ammonia	
5	EVT_OUT	Event output	0	0	6-OFF	
6	EVT_OUT	Event output			7-OFF	
7	NO-OP	No opcode				
8	NO-OP	No opcode				
9	NO-OP	No opcode				
10	NO-OP	No opcode				
11	NO-OP	No opcode				
12	NO-OP	No opcode				
13	NO-OP	No opcode				
14	NO-OP	No opcode				
15	NO-OP	No opcode				
16	NO-OP	No opcode				
17	NO-OP	No opcode				
18	NO-OP	No opcode				
19	NO-OP	No opcode				
20	NO-OP	No opcode				
21	NO-OP	No opcode				
22	NO-OP	No opcode				
23	NO-OP	No opcode				
24	NO-OP	No opcode				

Flow Section

**Nitriding Gas Supply**

The Nitriding gas supplies enter the flow section from the top. Each gas has a manual shut off valve as well as a regulator (regulators optional). The regulators are to protect against fluctuations in incoming supply pressures. The location for each incoming gas inlet is as follows from left to right: Nitrogen, Ammonia, and Disassociated Ammonia. Pressure regulation should be set between 12 and 20”.

**High and Low Pressure Switches**

Each gas has a High and Low pressure switch. The location of these switches are just below the manual valves for the incoming gas. The High Pressure Switch is on top and the Low Pressure Switch is on the bottom. The switches have green LED indicators to indicate the pressure condition. Example, If the LED indicator is OFF on the High Pressure switch then the incoming pressure from the supply gas is to high and



the condition generates an audible alarm. Each pressure switch has a dial setting on the front to make adjustments to the switch. The pressure switches are set by SSi at the time of panel checkout. SSi presets the regulators for 15" water. The High and Low Pressure switches are set based on this value. Any questions on the settings please call SSi technical support at 513-772-0060.

### Vessel Pressure Switches

Vessel Pressure is the accumulated pressure of all gases flowing through the furnace. The switches for Vessel Pressure are located to the immediate right of the gas pressure switches. These pressure switches have LED's to indicate high and low pressure.

### Sample Ports

Each gas has a sampling port below the pressure switches. To take a flow pressure reading using a manometer, just connect the manometer to the sampling port and turn the manual valve until it is open. Make sure the incoming supply valve for the gas being checked is also opened.

### Emergency Nitrogen

Emergency Nitrogen can be added to the system in the event of an emergency. The operator can initiate Emergency Nitrogen purge by turning the Emergency Nitrogen switch on the front of the control panel to ON. The Emergency Nitrogen solenoid is a normally open solenoid and will be open on power failure to the control panel.

### Flow Head Unit

The process gas flow system is located below the sampling. The flow head unit is divided into the following parts; flow control boards, valves, High and Low limits.

*Flow Control Boards* - Each gas has an individual flow control board associated with the gas. The board is located in the flow head unit and communicates to the 9210 controller. The flow control board has a comm port on it that can be switched between RS-485 and RS-232. The board must be in the RS-485 mode to communicate with the 9210. The RS-232 mode allows for communication directly to a PC running the configuration software. The RS-232 mode allows for downloading of flow curves and troubleshooting. On the front of the flow head unit the LED display shows flow of each gas in SCFH. The LED's on the front of the unit display the following: Auto/Manual, Alarm, V1, V2.

*Auto/Manual* - When the Auto/Manual LED is ON the board is in the Auto Mode being controlled by the 9210. The switch on the front of the control panel for each gas allows for the board to be put in Auto, Hand (Manual) or OFF. The LED will be OFF when the switch is in Hand position. The operator can turn the valve wheel by hand in this condition.

*ALM* - This indicator shows when the board is in an Alarm condition. Alarms include max range or high limit switch made.

*V1* - V1 indicates the direction the valve is moving. The LED is OFF when the valve is closing and ON when the valve is opening.

*V2* - V2 indicates the board is given a Run/Stop command. The LED is OFF when the valve is receiving a Stop signal. The LED is ON when the valve is being given a Run signal.

*Valves* - Each gas has a needle valve attached to a motor. The motor drives the needle valve via a worm gear. The needle valve shaft has a wheel attached with a set screw that allows the valve to be turned by hand. If adjusting the wheel by hand unplug the connector from the drive so the 9210 is not trying to open or close the valve during hand adjustment.

*Limit Switches* - Each valve has a limit switch that will not allow the valve to open past a preset limit.

***These upper limits need to be set in the field for each gas.*** Before setting the upper limit, the maximum SCFH needs to be known for each flow meter. Instructions for setting the upper limits are as follows:

1. Loosen the set screw on the wheel.
2. Send a setpoint to the valve to obtain the maximum flow desired.
3. Allow the valve to settle at the desired flow.
4. Pull the wheel up till the limit switch is activated.
5. Tighten set screw.
6. Repeat for each valve.
7. Drive each valve closed and then open past the max range to test the limit switch. Be sure to have the event for that specific flow meter turned on under manual events.

### **Mass Flow Meters**

The Mass Flow Meters are located below the Flow Head Unit. The flow meters send a 4-20ma signal to the flow boards to indicate actual flow. If there is no flow it will trigger a Lo FL alarm. If the flow meter has reached its maximum, all LED's will be ON and the last one will be flashing. Each Mass Flow meter is calibrated for a specific range of flow depending on the gas associated with the meter.

### **Gas Solenoids**

Each gas has an associated solenoid, which turns on to allow flow. The gas solenoids are located below and behind the Mass Flow Meters. The gas solenoids can be activated manually by turning the switch on the control panel to HAND for the appropriate gas. The solenoids are also controlled by the 9210 through the events in the recipe and on the manual events menu screen.

### **Back Pressure Valve**

The Back Pressure valve is located behind and to the right of the Flow Head Unit. The Back Pressure valve is attached to the exhaust of the furnace. The valve provides the necessary back pressure to allow flow through the Sample Cell. The valve also provides the ability to restrict the outside oxygen from entering the furnace through the exhaust. During a power outage the Back Pressure valve opens fully to vent all gases and nitrogen purge out of the furnace.

### **Differential Pressure Transmitter**

The Differential Pressure Transmitter is located to the right and below the Gas Solenoids. The transmitter sends a signal to the 9210 which controls the amount of back pressure to be applied to the system. It is critical that no restrictions in the line other than the back pressure valve create the actual pressure. IF the back pressure valve indicates pressure higher than setpoint and the valve is open this is an indication of a restriction or water down stream.

### **Drip Legs**

There are three drip legs associated with the flow section. The drip leg valves need to be opened under the following conditions;

1. Whenever heating up the furnace under air. Heating the furnace under air causes condensation to build up in the exhaust. The buildup of water in the exhaust lines affects the back pressure reading. The error in back pressure will affect the reading of the sample and directly affect dissociation readings.
2. Prior to the addition of ammonia into the furnace. After the heat up of the furnace, when the furnace is at temperature, the drip legs should be opened briefly to allow any water buildup to escape.
3. Any time during blowout of lines during cool down cycles and Nitrogen flow.

**DO NOT OPEN DRIP LEGS DURING AMMONIA FLOW OR DISASSOCIATED AMMONIA FLOW. GASES ARE TOXIC AND VERY HAZARDOUS.**

The location of the drip legs are as follows:

1. At the bottom of the exhaust line
2. Below the differential pressure transmitter.
3. bottom of the Sample Cell.

**Sample Cell Solenoid**

The Sample Cell solenoid is energized by event 7 through the program or manual event control. The solenoid should only be energized when the furnace is up to temperature and the event is turned ON. Gas is allowed to flow to the sample cell when the solenoid is energized.

**Sample Cell Filter**

The filter on the inlet side of the Sample Cell Box can become clogged. The part number for a replacement filter is 37051.

**DO NOT CHANGE THE FILTER WHILE AMMONIA OR DISASSOCIATED AMMONIA IS FLOWING. THE GASES ARE TOXIC AND VERY HAZARDOUS.**

The steps for replacing the filter are as follows;

1. Close all incoming gas valves.
2. Unscrew the clear bowl from the filter housing.
3. Unscrew the filter holder. The holder is the black plastic knob in the center of the filter.
4. Pull off old filter and replace with new.
5. Screw the filter holder back into the top of the filter housing.
6. Screw the clear bowl back on the housing.
7. Open incoming gas lines

Flow to the sample cell should be a minimum of .5 scfh and a maximum of 2.0. This flow is critical to the nitriding process. If flow is low replace the filter. **If you are unable to maintain flow contact Super Systems Inc at 1-513-772-0060 immediately.**

# Super Systems Nitriding Sample Cell

## 1.0 Introduction

### 1.1 Applications

This Card is designed to be a Nitriding Sample Cell for Super Systems.

The unit is calibrated for either

- (1) 0 to 100% Hydrogen in a background of Methane and Carbon monoxide.
- (2) 0 to 75% Hydrogen in dissociated Ammonia (calibrated on 100% H<sub>2</sub>)

### 1.2 System Description

The system comprises an electronic unit Consisting of two PCBs mechanically connected via pillars. The lower card provides power and process control options The secondary card with the Nitriding Sample Cell mounted on it offers the signal conditioning and communications port.

### 1.3 System Highlights

The Unit is provided:

- PCB mounted Nitriding Sample cell
- RS232/485 Communications
- Voltage free contacts (optional)
  - a. High alarm 1:-option
  - b. High alarm 2:- option
- Isolated analog output (0...5V) Optional
- 24V power supply.

### 1.4 Unpacking and Visual checking

Take all normal precautions when opening the packages. In particular, avoid the use of long bladed cutters. Check that all pipe connections have compression nuts and olives intact. Search packing if any are missing. Check for any sign of damage. Carefully remove any internal packing material.

## 2.0 SPECIFICATION

### 2.1 Enclosure - NA

### 2.2 Dimensions

Electronics unit: H. 180mm W.85mm D.60mm See figure 1.

### 2.3 Ambient Temperature

Sensor unit: -10...50°C Max

### 2.4 Display - NA

### 2.5 Analog outputs – isolated (Optional)

4...20mAV proportional to 0..100% Hydrogen (minimum load 500 ohm.) Optional

### 2.6 Alarm indicators (Optional)

Voltage free contacts SPDT Relay 1A /120Vac or 2A /240Vac

- High alarm 1 relay (Set to 0.6% Hydrogen)
- □High alarm 2 relay (Set to 1.0% Hydrogen)

### 2.7 Communications RS232

Set up: 9600 Baud, 1 start bit, 8 data bits, 1 stop bit, no parity, hardware (CTS/RTS) handshaking.  
See Appendix 1 for proposed communication protocol.

DTE male 9w	
PIN	NAME
3	TX(out)
2	RX (in)
7	RTS (out)
8	CTS (in)
5	GND

RS485  
Optional

2.8 Speed of Response

Typical T90 for combustion gas application is 30 seconds.

2.9 Power Requirements

Voltage: 24Vdc +/- 5%

Power: 10W

2.10 Gas Connection

The standard connections are captive seal compression fittings suitable for 0.25" (or 6mm) diameter tube on the sample inlet and sample outlet. The tubing must be sturdy enough to withstand the slight compression applied by the tightened coupling. Metal, nylon or other rigid plastics are suitable. Rubber, PVC etc. are only suitable if a supporting insert is used. See figure 1 for inlet / outlet

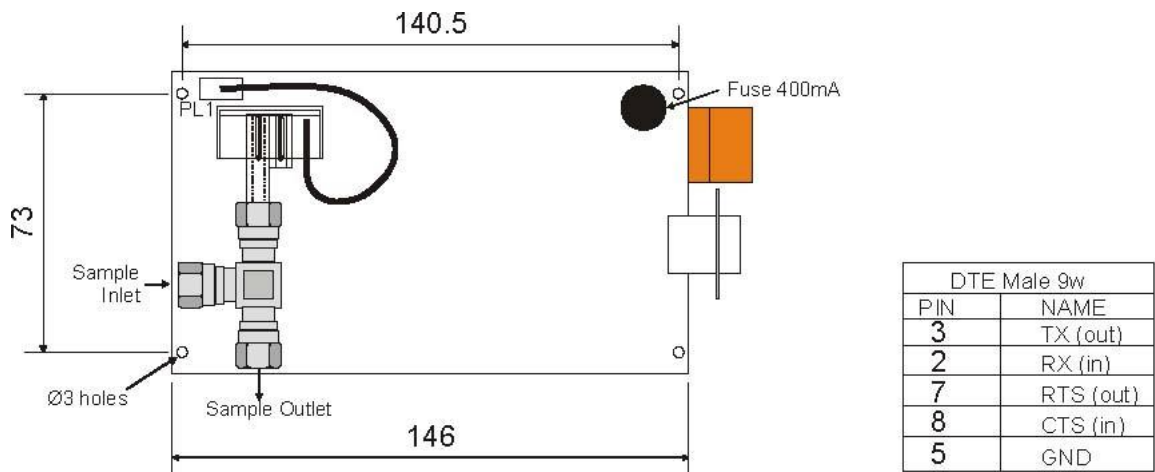

78

**Figure 2:**  
**Sensor**

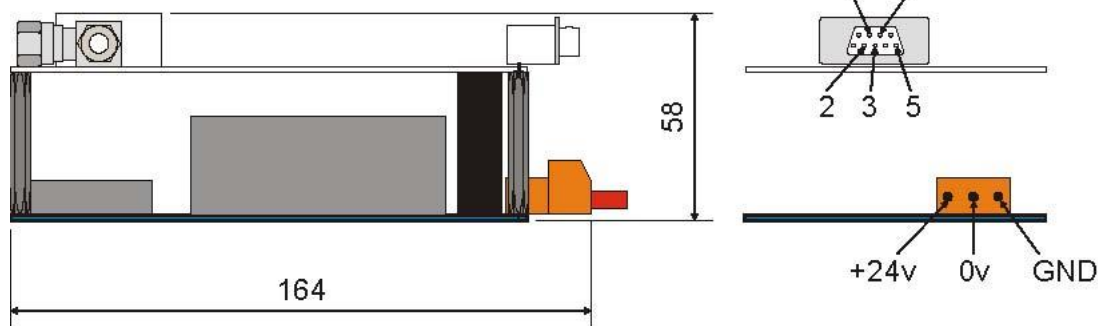

**Figure 1: Enclosure dimensions**

## 4.0 CALIBRATION

### 4.1 General Frequency

The Nitriding Sample Cell based analyzer is an extremely stable instrument and requires only very occasional calibration. The exact calibration period depends on the type of sample and environment the instrument is placed in. We recommend that any quality assurance procedures written for the instrument are written to allow verification as opposed to calibration. Verification involves checking that the instrument provides the correct analysis of a standard gas within the limits of the instrument and only calibrating when a result outside of limits is produced. The frequency of the verification would need to be in line with the quality regime being operated by the user.

### 4.2 Calibration method

**NOTE:** Calibration requires a computer (laptop) with an available serial port and HyperTerminal software.

Introduce the calibration gas in the same way as the normal sample. The sample cell should be isolated from the process gas and the calibration gas introduced into the Sensor at the correct flow rate. Note that pressure regulators and gauges that may be in the calibration gas lines all have a certain amount of dead space within them and so may require purging for several minutes before the delivered gas matches that of the cylinder contents. Only when the reading is steady has the dead space been purged.

The recommended order of calibration is:

□□ *Zero=xxx.xx<CR><LF>.command where xxx.xx = 0 (See appendix 1)*

The Zero point will use 100% Nitrogen

□ *Span=xxx.xx<CR><LF>.command where xxx.xx = 100 (See appendix 1) The Span point will use 100% Hydrogen*

## 5.0 TECHNICAL INFORMATION

The Nitriding Sample Cell is a device that produces an output that is a function of the thermal conductivity of the gas surrounding its sensor. Gases differ in their thermal conductivity and the thermal conductivity of a mixture is approximately the mathematical average of the thermal conductivity and concentration of each component. Because thermal conductivity is a bulk physical property of the gas its measurement is not specific for any component. The Model 9210 is programmed in such a way that it assumes the components are always the same species, e.g. oxygen, nitrogen and carbon dioxide. If a gas mixture containing other components is introduced into the sample cell it will not produce the correct readings.

## 6.0 SERVICING

The Nitriding Sample Cell sensor is non-depleting and will last indefinitely if not subjected to misuse. The sensor can only be replaced by the use of specialist equipment and would have to be returned to Super Systems or their agent should a replacement be required.

Questions on the analyzer should be directed to Super Systems Inc. It is important that the serial number or job number are quoted. These numbers may be found on the data label on the rear panel.

Super Systems Inc  
7205 Edington Drive  
Cincinnati, OH 45249  
513-772-0060, 513-772-0060  
Fax: 513-772-9466  
[www.supersystems.com](http://www.supersystems.com)



## Appendix 1

### 1.1 Communications Protocols.

#### 1.2 RS232 Command communications.

Data is transmitted upon request *in normal operation and calibration* modes.

Transmission is suspended during boot and in edit mode, and in the case of an error. The protocol can be either in a terse format (i.e. **D**) or in instruments supporting the extended readable format (i.e. Data).

Command : DTE to instrument Format : *Command=xxx.xx <CR><LF>*.

Command	function	reply
<i>Data=x&lt;CR&gt;&lt;LF&gt;</i> .	Request for diagnostic data. Optional ="x" is specifying the required line of data	D2 Ref=1234b D1 M1=2222b
<i>Reading=x&lt;CR&gt;&lt;LF&gt;</i> .	Request for Reading. Optional ="x" is specifying the required line of reading in sensor with multiple data sets.	R2 CO2=0.01r R1 H2=20.0%
<i>Zero=xxx.xx&lt;CR&gt;&lt;LF&gt;</i> .	Request to zero the sensor assumed 0.00. Optional. ="xxx.xx" is specifying the zero point data.	Z1 pass or Z1 fail
<i>Span=xxx.xx&lt;CR&gt;&lt;LF&gt;</i> .	Request to Span the sensor. data assumed 100.00% of sensors span. ="xxx.xx" is optional specifying the Span point data. Otherwise.	S1 pass or S1 fail

=XXX.xx is optional and must be preceded by an "=" and is used to set the value of the action.

The message is: Request Y Quantity = xxxxx unit <CR><LF>.

**Request:** is the first character of the command D R S Z

**Y:** is the line number for the data.

The highest line number is always presented first hence line 1 is always the last data line of a communication.

Extension is when "x" is specified the only that line number will be returned.

**Quantity:** is one of H2 CO CO2

**xxxx:** is the measured quantity. The resolution is the same as the display:

**Unit:** is one of % percent r compensation ratio

The compensation ratio is the diagnostic data for instruments with a secondary gas background. When requested as a data it will return the present ratio for compensating the primary measured gas "R1"

I.e. for H2 in N2 with a secondary gas of CO2

D1 CO2=0.069r If you know the concentration of the CO2 can calculate the correction in the H2 reading as  $H2 - (CO2 * 0.069)$

In over-range condition (when the display shows 'HI') xxxxx will be '+++++' In under-range condition (when the display shows 'LO') xxxxx will be '-----'

Controller.	Sensor	
Reading	R1 H2= 98.5%	Instrument request a reading
Span=99.0	S1 Pass	Controller requests a span setting of 99.0%
Reading	R1 H2= 99.0%	

I.e. this would set the present instrument reading to 99.0% The unit "%" is assumed to be the same as the reading.

#### Error messages

Error messages take the form '? xx' where 'xx' is a numeric code as explained below Comms. Errors:

Code	Error	Description
90	Buffer overflow	More than 15 characters were received without message terminator (<CR><LF>). Any subsequent characters will begin a new message.
91	Message timeout	10 seconds has elapsed since the last character was received without message terminator.
92	Bad opcode	Message was received correctly terminated but not understood (e.g. 'Fred=1<CR><LF>')
93	Bad operand	Message was received correctly terminated and understood but the line number wasn't (e.g. 'Reading=Q<CR><LF>').

## System errors

Code	Error	Description
71-76	NVRAM CRC error	Three areas exist (1,3 & 5) each with a backup (2,4 & 6). Area 1 contains user parameters i.e. calibration data and the backup is write protected so if this area is restored user calibration etc is LOST. Error 71 will be reported in response to any read request until either a calibration is performed or the instrument is rebooted. Areas 3 & 5 are read only so they can be silently restored. Errors 73 & 75 therefore should never be reported, although they exist internally until they clear themselves. Errors 72,74 & 76 will be reported in response to any read request and cannot be cleared.
77- 78	TCD curve error	In reading curve data from EEPROM the instrument has attempted to read beyond the ends of the curve.
79	Wrong block no.	The serial numbers of the Nitriding Sample Cell stored in areas 1 & 5 (in separate devices) do not match
80	UART missing/error.	For debugging only. Since the only interface available is RS232, this error can never be reported!
81	Reserved	For external EEPROM not found.

## Nitriding Sample Cell cleaning

### Safety Notes- *Warning!*

Hazardous gas or dangerous chemicals formed by the process may be present.  
Check with your site safety officer before handling or removing the sensor.  
Isolate all external circuits before removing sensor.

### *Important!*

Do not push objects into the sensor, it is easily damaged!  
The sensor must be dry before it is reconnected and power applied.

1. Remove sensor from its mounting bracket by slackening the mount fitting  
(See Figure 1).
2. Disconnect the cable according to connector type:
  - Terminal: Unscrew the connections ensuring the label specifying color is still present. If removed note the color sequence.
  - Push fit: Gently pull the latching part to remove the connector.
3. Wash the sensor in de-ionized water by filling the sensor tube and repeatedly flushing. Use gentle agitation for a deeper clean.
4. Drying can be achieved by:
  - Washing the sensor with iso-propanol (IPA) then immediately blowing dry air or heating (max 60c).
  - Allowing Nitrogen (dry gas) to flood the cell for a period of 12 hours. Heating (max 60c) can reduce time period.

**WARNING:** Flammable, do not use on live electrical equipment or other sources of ignition.

5. Refit sensor and allow the reading to settle before following the calibration routine specified in the user manual.

(FIG. 1)

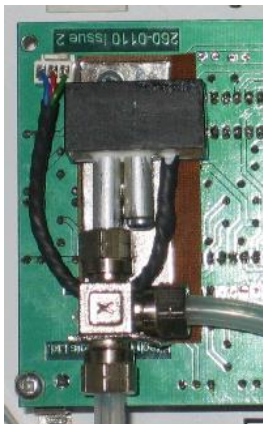

## Appendix 2 - TC Type mV Range Chart

<u>TC Type</u>	<u>Range in mV</u>
B	20
C	40
E	80
J	80
K	80
N	80
NNM	80
R	40
S	20
T	20

### Appendix 3 – Changing the Date/Time of the Touch Screen Display

If the date or time needs to be changed on the Touch Screen display unit, use the following steps:

1. Exit the 9210 display by selecting the “Shutdown” menu option from the “Menu” menu.
  - a. Click on the **Enter** button along the bottom of the screen to select the menu option.
  - b. Click on the **Yes** button to confirm the program close.
2. Once the 9210 display has closed, double-click on the time in the taskbar in the lower left corner. This will bring up the dialog to change the date or time.

OR

3. Go to Start Menu → Settings → Control Panel
  - a. Click on “Date/Time” once and select File → Open or
  - b. Double-click the “Date/Time” icon to open the Date/Time dialog
4. If necessary, select the new date from the calendar by clicking on the date. Months can be changed by using the left or right arrow buttons next to the month/year on the calendar.
5. If portions of the dialog are not visible due to the screen size, click and hold the title bar and move the dialog by dragging the dialog.
6. If necessary, select the new time zone from the drop-down list.
7. Check the “Automatically adjust clock for daylight saving” checkbox if desired.
8. If necessary, adjust the time:
  - a. Highlight the hours, minutes, or seconds by clicking on the desired section. When selected, the section will be highlighted in blue.
  - b. Use the up or down arrows to change the selected section
9. Click on the **Apply** button or the **OK** button at the top of the dialog to save the changes
10. If no changes were made, click on the **X** button in the top right of the dialog to close the dialog
11. Cycle the power to the 9210 Touch Screen to bring up the 9210 display again.

## Appendix 4 – Calibration of SSI Analog Input Boards

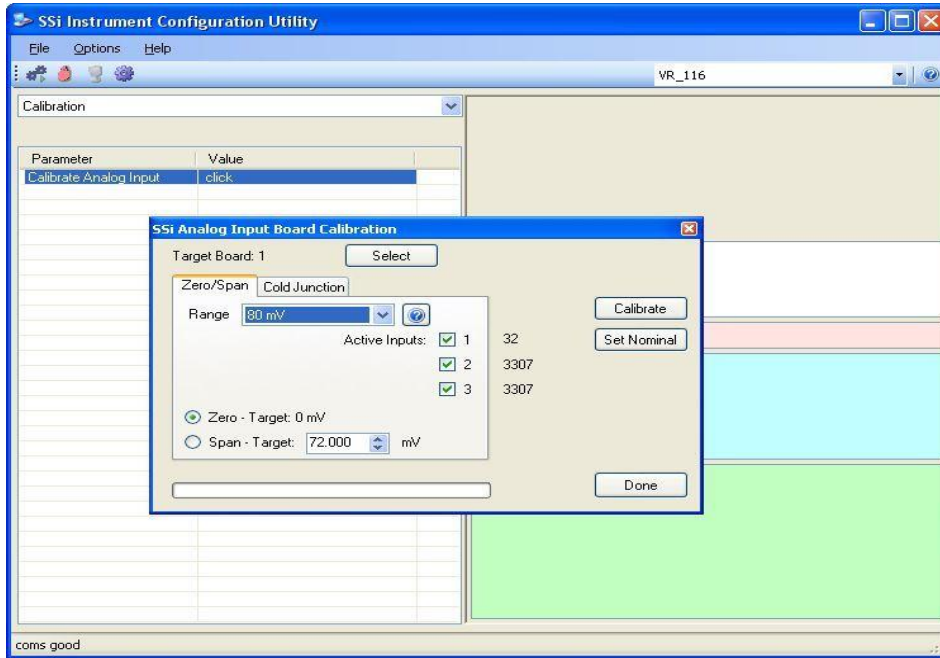

The Calibration menu screen will allow the user to calibration the zero, span, and cold junction trim value for all of the inputs on each board. The **Select** button will allow the user to select one of the current boards to perform a calibration on. Select the appropriate board and click on the **OK** button. Clicking on the **Cancel** button will not select the board to calibrate. *Note: A board must be selected for calibration to begin.* The user will need a thermocouple calibrator

capable of outputting a thermocouple signal to calibrate the zero, span or cold junction value of the video recorder data logger. The user will need to connect the calibrator to one of the inputs on the data logger for the channel that will be calibrated. It is recommended to let everything (calibrator and datalogger) sit for approximately thirty minutes to allow the temperature to achieve equilibrium. Set up the calibrator for the specific thermocouple

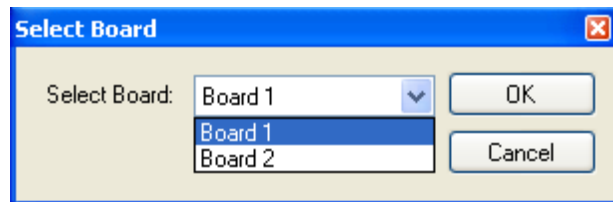

type of the thermocouples in the video recorder datalogger, i.e. type K, type J, etc. Then, source a specific temperature, like 1000 °F, or millivolt to the connected input. It is recommended that the actual temperature used be similar to an appropriate process temperature. For example, if your equipment normally operates at 1700 °F, then perform the cold junction calibration using a 1700 °F signal. It is

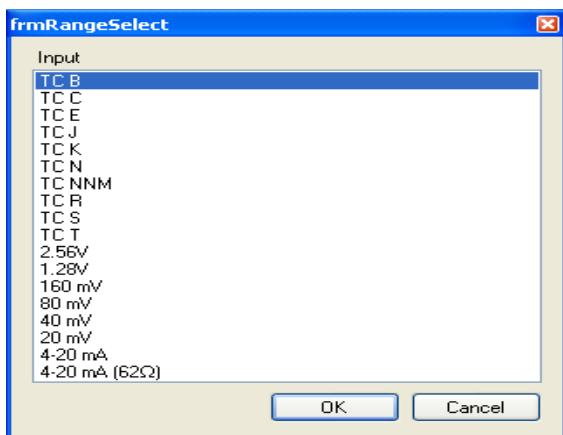

important to note that when performing a zero or span calibration, *do not use* regular thermocouple wiring. Instead, use any kind of regular sensor wire, or even regular copper wire. To perform the calibrations, the user will need a calibrator that is capable of outputting volts, millivolts, and temperature.

The "Zero/Span" tab will allow the user to perform a zero and span calibration on the selected board.

The help button -  - next to the "Range" drop-down list will allow the user to select a range based upon an input type if the range is not known.

Select the input type and click on the **OK** button. The correct millivolt range will be displayed in the drop-down

list. Click on the **Cancel** button to cancel this action.

Below is a listing of the suggested ranges for the various TC types.

## TC Type mV Range Chart

TC Type	Range in mV
B	20
C	40
E	80
J	80
K	80
N	80
NNM	80
R	40
S	20
T	20

### Zero Calibration

To perform a zero calibration, click on the “Zero” option. The circle will be filled in for the selected option. The drop down list under “Range” will allow the user to select the millivolt range of the inputs being calibrated. When a range is selected, the recommended value will also be populated. For a zero calibration, the recommended value is **0**. The list of ranges is:

20 mV  
40 mV  
80 mV  
160 mV  
1.28 Volt

The user can individually select each input (one through three/five) to calibrate, where Check = yes (calibrate) and No Check = no (do not calibrate). Once an input is checked, its current value will be displayed.

For a zero calibration, a value of 0 mV will need to be sourced to the input or inputs.

Click on the **Calibrate** button to begin the calibration.

The **Set Nominal** button will set *all* calibration values to their theoretical values. *Note: This function is not a factory default calibration.* This function would be useful if the user wished to restart a calibration from scratch.

A progress bar will be displayed along the bottom of the screen giving the progress of the calibration.

### Span Calibration

To perform a span calibration, click on the “Span” option. The circle will be filled in for the selected option. The drop down list under “Range” will allow the user to select the millivolt range of the inputs being calibrated. When a range is selected, the recommended value will also be populated. For a span calibration, the recommended value is 90 % of the full range. For example, if the range is 80 mV, then the span should be **72**. The recommended value can be changed either by using the up and down arrows to adjust the value, or by clicking on the value, and entering the new value that way. The user can also individually select each input (one through five) to calibrate, where Check = yes (calibrate) and No Check = no (do not calibrate). Once an input is checked, its current value will be displayed.

For a span calibration, a value of 90 % of the full range will need to be sourced to the input or inputs.

Click on the **Calibrate** button to begin the calibration.

The **Set Nominal** button will set *all* calibration values to their theoretical values. *Note: This function is not a factory default calibration.* This function would be useful if the user wished to restart a calibration from scratch.

A progress bar will be displayed along the bottom of the screen giving the progress of the calibration.

### Cold Junction Calibration

The “Cold Junction” tab will allow the user to perform a cold junction trim on the selected board.



The user can select the input to perform the trim on from the "Input:" box. The user can enter the cold junction offset in the "Offset:" box. The current cold junction value will be displayed next to the "CJ:" line. Also, the current values from the selected inputs will be displayed on the right of the tab. To display an input's value on the "Cold Junction" tab, click on the "Zero/Span" tab and check that input's checkbox, then return to the "Cold Junction" tab. Click on the **Calibrate** button to begin the calibration. Click on the **Done** button to close down the screen.

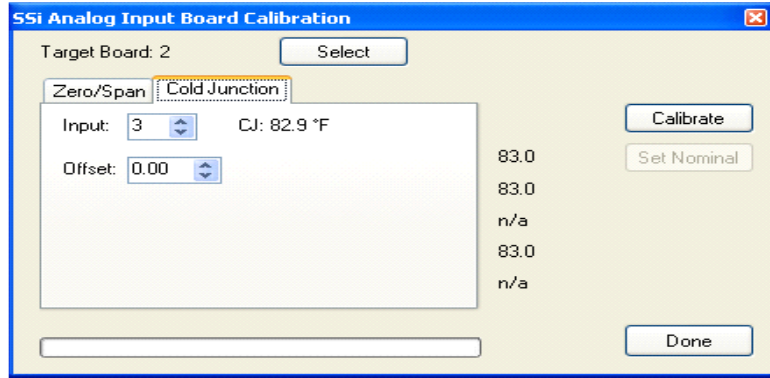

## Appendix 5 – 9210 Nitrider Typical Configuration

<b>Revision</b>	
Revision	1.68
<b>PID Loop 1 Setup</b>	
Prop Band (0 for On/Off)	35.0
Reset	0.50
Rate	0.00
Mode	Dual Direct
Integral Preset	0
Cycle Time	24
Setpoint Change Limit	Off
Low Limit	-100
High Limit	100
0 Setpoint stops control	No
IN1 high limit shuts down ctrl	No
IN2 high limit shuts down ctrl	No
IN3 high limit shuts down ctrl	No
PID auto switch	No
Switch point PID 1 → 2	99.99
Switch point PID 2 → 3	99.99
Overshoot limit gain	0
Deviation setpoint	Off
Dev. Alarm delay (sec)	0
Setpoint lower limit	-99.99
Setpoint upper limit	299.99
<b>PID Loop 2 Setup</b>	
Prop Band (0 for On/Off)	5.0
Reset	0.04
Rate	0.00
Mode	Single Reverse
Integral Preset	0
Cycle Time	6
Setpoint Change Limit	40 %
Low Limit	0
High Limit	100
0 Setpoint stops control	No
IN1 high limit shuts down ctrl	No
IN2 high limit shuts down ctrl	No
IN3 high limit shuts down ctrl	No
PID auto switch	No
Switch point PID 1 → 2	9999
Switch point PID 2 → 3	9999
Overshoot limit gain	0
Setpoint lower limit	-9999
Setpoint upper limit	9999
<b>PID Loop 3 Setup</b>	
Prop Band (0 for On/Off)	20.0
Reset	0.50
Rate	0.00
Mode	Single Reverse
Integral Preset	0

Cycle Time	60
Setpoint Change Limit	Off
Low Limit	0
High Limit	100
0 Setpoint stops control	No
IN1 high limit shuts down ctrl	No
IN2 high limit shuts down ctrl	No
IN3 high limit shuts down ctrl	No
PID auto switch	No
Switch point PID 1 → 2	99.99
Switch point PID 2 → 3	99.99
Overshoot limit gain	0
Deviation setpoint	Off
Dev. Alarm delay (sec)	0
Setpoint lower limit	-99.99
Setpoint upper limit	299.99
<b>Event Run Program Setup</b>	
Program number to run	0
<b>Load TC Setup</b>	
Load TC Enable	Off
Control TC	
TC 1	
TC 2	
TC 3	
TC 4	
TC 5	
TC 6	
TC 7	
TC 8	
TC 9	
TC 10	
TC 11	
TC 12	
TC 13	
TC 14	
TC 15	
TC 16	
TC 17	
TC 18	
TC 19	
TC 20	
TC 21	
TC 22	
TC 23	
TC 24	
<b>Port Setup</b>	
Host 232 Baud	19200
Host 232 Mode	Modbus Master/PLC
Host 485 (3,4) Baud	19200
Host 485 (3,4) Mode	Modbus
Host 485 Address	1

Slave 1 (5,6) Baud	19200
Slave 1 (5,6) Mode	Modbus Host
Slave 2 (22,23) Baud	19200
Slave 2 (22,23) Mode	Modbus
232/H2 Port Baud	9600
PLC Type	Micrologix Modbus
<b>Slave Instrument Setup</b>	
Instrument 1	SSi 7SL @ 2 on slave 2
Instrument 2	SSi 7SL @ 3 on slave 2
Instrument 3	9100 LP2 @ 5 on slave 2
Instrument 4	
Instrument 5	
Instrument 6	
Instrument 7	
Instrument 8	
Instrument 9	
Instrument 10	
Instrument 11	
Instrument 12	
Instrument 13	
Instrument 14	
Instrument 15	
Instrument 16	
Instrument 17	
Instrument 18	
Instrument 19	
Instrument 20	Micrologix PLC @ 1 on RS-232
Instrument 21	Micrologix PLC @ 1 on RS-232
Instrument 22	Micrologix PLC @ 1 on RS-232
Instrument 23	
Instrument 24	
Instrument 25	Micrologix PLC @ 1 on RS-232
<b>Zone 1 Assignment</b>	
Atm Instrument	Loop 1
Atm Zone Number	0
Default Zone offset, atm	0.00
Temp instrument	Loop 1
Temp zone number	0
Default zone offset, temp	0
<b>Zone 2 Assignment</b>	
Atm Instrument	Loop 1
Atm Zone Number	0
Default Zone offset, atm	0.00
Temp instrument	Loop 1
Temp zone number	0
Default zone offset, temp	0
<b>Zone 3 Assignment</b>	
Atm Instrument	Loop 1
Atm Zone Number	0
Default Zone offset, atm	0.00
Temp instrument	Loop 1

Temp zone number	0
Default zone offset, temp	0
<b>Zone 4 Assignment</b>	
Atm Instrument	Loop 1
Atm Zone Number	0
Default Zone offset, atm	0.00
Temp instrument	Loop 1
Temp zone number	0
Default zone offset, temp	0
<b>Zone 5 Assignment</b>	
Atm Instrument	Loop 1
Atm Zone Number	0
Default Zone offset, atm	0.00
Temp instrument	Loop 1
Temp zone number	0
Default zone offset, temp	0
<b>Furnace Setup</b>	
PVT Type	Nitrider
Nitrider Mode	H2 and Dissociation
Nitrider Control	Control
H2 cell type	Hi
H2 RS-232 Comms	Yes
Temperature Display	Internal
Lp3 control	Backpressure
Valve 1 (Nitrogen)	Yes
Valve 2 (Ammonia)	Yes
Dissociated Ammonia	Yes
Hydrogen	No
Temperature mode	°F
Programmer type	Nitrider
Atmosphere instrument	Loop 1
Temperature instrument	Loop 2
Event instrument	Instrument 20
Quench instrument	Instrument 13
End of quench event	0
Quench speed event	0
Quench run event	0
Nitrider bias	0.0
Date and time	<System Date>
Default hold time (min)	5
Deviation alarm delay (min)	0
PLC type	Micrologix Modbus
Flow signal	Analog/PLC
Clear events, end of recipe	No
<b>Wait Limits</b>	
Temp wait limit	25
Atm wait limit	1.0
<b>Furnace Name</b>	
Furnace Name	Nitrider 83
PV1 Name	
PV2 Name	

PV3 Name	
<b>Alarm 1 Setup</b>	
Setpoint	800
Alarm Type	PV1 Band NO
Hysteresis	1
Smart Alarm	Disabled
ON Delay Time (sec)	3600
<b>Alarm 2 Setup</b>	
Setpoint	1400
Alarm Type	PV2 proc high
Hysteresis	10
Smart Alarm	Disabled
ON Delay Time (sec)	0
<b>Alarm 3 Setup</b>	
Setpoint	1400
Alarm Type	PV2 proc high
Hysteresis	1
Smart Alarm	Disabled
ON Delay Time (sec)	0
<b>Relay Assignments</b>	
Relay 1	Event 0
Relay 2	Event 1
Relay 3	Event 2
Relay 4	Event 3
Relay 5	Event 4
Relay 6	Event 5
Relay 7	Event 6
Relay 8	Program, alm1, flow dev
<b>Relay Setpoints</b>	
Relay ON SP for IN1 A	0
Relay OFF SP for IN1 A	0
Relay ON SP for IN1 B	0
Relay OFF SP for IN1 B	0
Relay ON SP for IN1 C	0
Relay OFF SP for IN1 C	0
Relay ON SP for IN2 A	0
Relay OFF SP for IN2 A	0
Relay ON SP for IN2 B	0
Relay OFF SP for IN2 B	0
Relay ON SP for IN2 C	0
Relay OFF SP for IN2 C	0
Relay ON SP for IN3 A	0
Relay OFF SP for IN3 A	0
Relay ON SP for IN3 B	0
Relay OFF SP for IN3 B	0
Relay ON SP for IN3 C	0
Relay OFF SP for IN3 C	0
<b>Input 1 Setup</b>	
Input type	K
Filter time	0
Initial scale	0

Full scale	10000
Decimal Point location	0
Open TC	Up scale
Input offset	0
Trip point 1 setpoint	0
Trip point 1 force value	0
Trip point 1 direction	Input above setpoint
Trip point 2 setpoint	0
Trip point 2 force value	0
Trip point 2 direction	Input above setpoint
High input limit setpoint	-32768
High input limit hysteresis	-32768
<b>Input 2 Setup</b>	
Input type	4-20 mA
Filter time	0
Initial scale	-27.99
Full scale	28.00
Decimal Point location	2
Open TC	Up scale
Input offset	0.00
Trip point 1 setpoint	0.00
Trip point 1 force value	0.00
Trip point 1 direction	Input above setpoint
Trip point 2 setpoint	0.00
Trip point 2 force value	0.00
Trip point 2 direction	Input above setpoint
High input limit setpoint	-327.68
High input limit hysteresis	-327.68
<b>Input 3 Setup</b>	
Input type	K
Filter time	0
Initial scale	0
Full scale	10000
Decimal Point location	0
Open TC	Up scale
Input offset	0
Trip point 1 setpoint	0
Trip point 1 force value	0
Trip point 1 direction	Input above setpoint
Trip point 2 setpoint	0
Trip point 2 force value	0
Trip point 2 direction	Input above setpoint
High input limit setpoint	-32768
High input limit hysteresis	-32768
<b>Output 1 Setup</b>	
Assignment	Loop 3 inc
Offset	0
Range	100
Current selection	4-20 mA
<b>Output 2 Setup</b>	
Assignment	Loop 2 inc

Offset	0
Range	100
Current selection	4-20 mA
<b>Passcodes</b>	
Level 1 code	1
Level 2 code	2
Web level 1 code	111
Web level 2 code	222
Web change enable	1
Programmer alarm	Normally open
Alarm 1	Normally open
Alarm 2	Normally open
Alarm 3	Normally open
<b>IP Address</b>	
IP Address	192.168.1.200
IP Mask	255.255.255.0
IP Gateway	192.168.1.1
<b>Event Control</b>	
Hold instrument number	0
Hold minimum PV	0
Hold maximum PV	2000
Event for program run	-1
Event for program reset	-1
Event 0	
Event 1	
Event 2	
Event 3	
Event 4	
Event 5	
Event 6	
Event 7	
Event 8	
Event 9	
Event 10	
Event 11	
Event 12	
Event 13	
Event 14	
Event 15	
<b>Valve Setup</b>	
Control mode	Individual trim
DA switch point	60
Auto valve event	No
<b>Valve 1 Input</b>	
Zero scale	0
Full scale	300
Trim enable	No
Target setpoint	150
Trim range	0
Zero SP scale	0
Full SP scale	300



Valve max	300
Deviation setpoint	20
Dev. Alarm delay (sec)	300
Gas type	Nitrogen
Valve decimal place	0
<b>Valve 2 Input</b>	
Zero scale	0
Full scale	300
Trim enable	Yes
Target setpoint	150
Trim range	50
Zero SP scale	0
Full SP scale	300
Valve max	300
Deviation setpoint	60
Dev. Alarm delay (sec)	60
Gas type	Ammonia
Valve decimal place	0
<b>Valve 3 Input</b>	
Zero scale	0
Full scale	150
Trim enable	No
Target setpoint	10
Trim range	25
Zero SP scale	0
Full SP scale	150
Valve max	150
Deviation setpoint	10
Dev. Alarm delay (sec)	300
Gas type	Dissociated Ammonia
Valve decimal place	0
<b>Valve 4 Input</b>	
Zero scale	0
Full scale	0
Trim enable	No
Target setpoint	0
Trim range	0
Zero SP scale	0
Full SP scale	0
Valve max	0
Deviation setpoint	Off
Dev. Alarm delay (sec)	0
Gas type	Hydrogen
Valve decimal place	0

## Revision History

Rev.	Description	Date	MCO #
-	Initial Release	04-24-2001	N/A
A	Added Revision History	01-26-2005	N/A
B	Added Flow Section	04-15-2005	N/A
C	Added Sample Cell Calibration and Cleaning	04-29-2005	N/A
D	Updated "Revision History" section – added "MCO #" column; Update screen shots; Updated Configuration menus; Added newer opcodes; Updated logo on title page; Updated "Valve Configuration" and "Valve Setup" sections	01-10-2008	2057
E	Update NitriDriD picture and SSi logo on title page; Add Flow Alarms with delays; Add DA Alarm examples with delays; Add in sample recipes – 24 step, not 12; Add in O2 Inquiry recipe; Add in auto-tuning & DF1 Setup features for Touchscreen; Add in Configurator 2.0 Menus; Changed <i>Port Setup</i> , <i>Adam Correction</i> Touchscreen menu; Removed original sample recipes from chapter 7; Added Appendix 4 – Calibration of SSi Analog Input Boards; Add in SSi Analog Input Offset enable for ADAM Modules; Added the following opcodes: BO_start, GDELAY, GHDELAY, GHZDELAY, GLDELAY, GLZDELAY, GTCINQDEL, GZDELAY, PIDLOAD, PLC_SET_VAL, RAMPRAUX, SET_LP3, SET_SL_VAL, SET_VALVE, SL_PV_INQ, timeEvt; Added the "9210 NitriDriD Typical Configuration" section; Added note about cold junction on the calibration sections	09-23-2010	2077
F	Added "User Alarm 0." Updated Title page and formatting	10/25/11	
G	Added operating range	7/28/2018	2235
H	Corrected 4-20mA resistor info	10/11/2018	2241
I	Added TS mounting instructions	12/3/2018	2245
J	Clarified Trip Point section	4/6/2022	2321
K	Removed screen saver information	11/7/2022	2330